



abro[®]
GROUP

fitness.abrogroup.com

Address : S.I.E Fateh Garh Road Abrona Street
Sialkot 51310 Pakistan.

Telephone : +92 523 250020, 550194

Mobile : +92 321 6109100

Email : info@abrogroup.com



PRODUTS

EQUIPMENTS

CLOTHING

ACCESSORIES



TABLE OF CONTENTS

Professional Boxing Gloves	Page 1-2
Training Boxing Gloves	Page 3-12
Junior Boxing Gloves	Page 13-16
Military Boxing Gloves	Page 17-21
Flag Boxing Gloves	Page 22
MMA Boxing Gloves	Page 23-31
Hand Wrap	Page 32-34
Weightlifting Boxing Gloves	Page 35-40
Weightlifting Straps	Page 41-42
Head Guard	Page 43-50
Mouth Guard	Page 51-52
Chest Guard	Page 53-54
Abdo Guard	Page 55-60
Shin Guard	Page 61-66
Knee Guard	Page 67
Ankle Guard	Page 68
Elbow Guard	Page 69-70
Wrist Wrap	Page 71

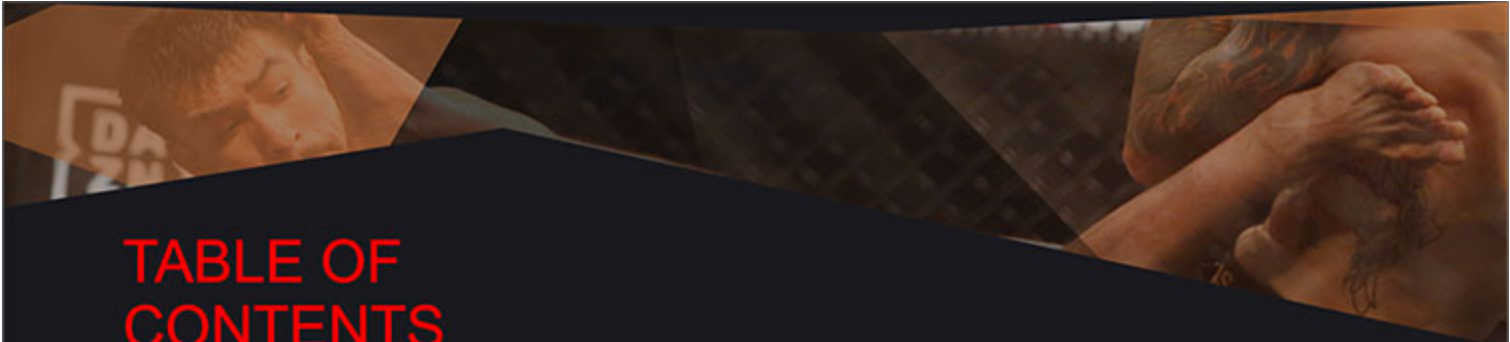

TABLE OF CONTENTS

Knee Wrap	Page 72
Taekwondo Gloves	Page 73-74
Taekwondo Shin Guard	Page 74
Taekwondo Shoes	Page 75
Punch MittsPage 76-79	Page 76-79
Punch Bags	Page 80-82
Kids Punch Bags with Gloves	Page 83-88
Kick Thai Shield	Page 89-92
Double End Bags	Page 93-94
Speed Bags	Page 95
Coaching Tools	Page 96
Ceiling Mount	Page 97-102
Neoprene Support	Page 103-108
Weight lifting Belts	Page 109-113
Weight Lifting Straps	page 114-118
Weight Lifting Accessories	Page 119-122
Training Equipments	Page 123
Fitness Bags	Page 124
Jump Ropes	Page 125-126
MMA Jui Jitsu Suits	Page 127
MMA Jui Jitsu Belts	Page 128
MMA Shorts	page 129
Compression Tights	Page 130
Compression Shorts	Page 131-132
Compression Suits	Page 133-134
Suna Suits	Page 135-136
Sports Bags	Page 137-138



BGL-PFC2K

DESCRIPTION

- Hand-suthentic cowhide leather encapsulates the shock interior of these foam laminated.
- Gloves technologically advance latex rubber mould offers shock-absorbency for power punchers without sacrificing speed.
- EVA padding throughout wrist along with foam padding in the cuff completes fist protection in all position.

SIZES 8 oz / 10 oz



SHELL-SHOCK™



BGL-PFA3K



DESCRIPTION

- Hand-stitched authentic cowhide leather is laminated With silver paper for the look of champions.
- light EVA foam padding coupled with horse-hair Lining makes the A-3 series a puncher's dream.
- EVA foam padding in the cuff ensures complete St-to-wrist protection when in duard or landing strikes

SIZES 8 oz / 10 oz

BGL-PFC3K1



BGL-PFC3K



DESCRIPTION

- 100% authentic cowhide leather is hand stitched and built For aggression.
- Technologically advanced latex rubber mould coupled with EVA foam and light cotton turns these bad boys into pillow For power punchers.
- latex rubber sheet in cuff completely encapsulate the gloves In shock-absorbent defenses

SIZES 8 oz / 10 oz



Shell-shock Foam with high density closed-cell shock-absorbency eats up Shock-impact with impunity.

Authentic cowhide leather encapsulates the shock-absorbent interior of these handcrafted gloves.



BGL-PFA2K

DESCRIPTION

- Authentic cowhide leather encapsulates the shock-absorbent interior of these foam laminated gloves.
- Max-shock foam with high density closed-cell shock-absorbency eats up Shock-impact with imp EVA padding coupled with foam protects the thumb for encompassed overall protection.

SIZES 8 oz / 10 oz

COLORS BLUE / RED



Supreme Shock™ Equilibrium FOAM
Technically advanced Equilibrium Sheet absorbs the blast of impact, distributing force equally across the boxing glove

Den2o Tree FOAM
Highly compressed layer provides added durability to impact resistance

Infrared Shock Dispersion SHEET
Advanced line of defense against shock impact helps dissipate and disperse force equally

Spongyx PADDING
Provides added resistance when met with high intensity force



QUICK-EZ HOOK & LOOP
SYSTEM GOES AROUND THE WRIST AND HOLDS IT TIGHT

Max-Shock™ Equilibrium FOAM

EVA-LUTION™ SHEET

- Advanced line of defense against shock-impact helps dissipate and disperse force equally
- Advanced expanding foam absorbs and distributes impact evenly across surface
- Provides added resistance when met with high-intensity force



BGR-F15BA

READY
TO GO

DAUNTLESS
AND
BEYOND



BGR-F15BA

SIZE CHART

FIGHTER WEIGHT (IN POUNDS)	FIGHTER WEIGHT (IN KILOGRAMS)	GLOVE WEIGHT (IN OUNCES)
98-113 LBS	45-51 KG	10 OZ
114-140 LBS	52-64 KG	12 OZ
141-160 LBS	65-73 KG	14 OZ
161-180 LBS	74-82 KG	16 OZ



• Highly compressed EVA-LUTION grip hose helps fill the glove for better punch formation and snug fit

• These hand-made gloves are layered with multiple sheets of gel-integrated padding that expertly absorb and disperse the blunt impact across the surface of the glove. This protects the hand from excess force, without minimizing the impact of your punch.



• Breathable palm helps to keep the hand ventilated, cool and encourages hygiene. Prevent fungal infections as well as fights offensive odors and bacterial growth.



• S.P.P. Ventilation with two strategically placed perforations ensure a steady stream of cool air to the thumb to prevent overheating.





Spongy Blacktop FABRIC

Polygonal Fusion FOAM

DenZo-Tron FOAM

 Infused Shock
Dispersion SHEET

SpongeX PADDING

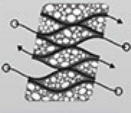
 QUICK-EZ
VELCRO CLOSURE

 EVALUTION
FOAM

 POLYGONAL
FUSION

BGR-F12

FIGHTER WEIGHT (IN POUNDS)	FIGHTER WEIGHT (IN KILOGRAMS)	GLOVE WEIGHT (IN OUNCES)
120 - 140 LBS	55 - 64 KG	12 OZ
160 - 180 LBS	73 - 82 KG	16 OZ

BGL-S5BK

SIZE CHART

FIGHTER WEIGHT (IN POUNDS)	FIGHTER WEIGHT (IN KILOGRAMS)	GLOVE WEIGHT (IN OUNCES)
98-113 LBS	45-51 KG	10 OZ
114-140 LBS	52-64 KG	12 OZ
141-160 LBS	65-73 KG	14 OZ
161-180 LBS	74-82 KG	16 OZ

(110OZ RECOMMENDED FOR UPTO 14 YEARS OF AGE)

Features:-

- Stitched with durable cowhide leather
- Low density Max-Shock foam padding sufficiently shields the hands and knuckles from the impact of blows.
- Gel-X protects the palm to give full coverage against all types of attacks; making this model a perfect kickboxing glove
- Quick-EZ Hook-and-loop closure for quick and efficient wear and removal
- Interior features a mesh lining that ventilates the hand, expels heat and keeps palm and fingers cool and comfortable

BGR-F7PK

- Polygonal Fusion MOLD**
Machine made interior polygonal cavities mold aligns itself to enhance the padding for heavy shock absorption
- Max Shock™ Equilibrium FOAM**
Technologically advanced Equilibrium Sheet absorbs the heat of impact, distributing force evenly across the hand
- Polygonal Fusion SHEET**
Machine made interior polygonal cavities sheet aligns itself to enhance the padding for heavy shock absorption
- Spongy Backtop FABRIC**
Backtop Laminated fabric with durability and responsiveness springs have sheet
- Calibrated Impact Diffusion SHEET**
Multiple layers of foam with gel in being serve as added shock absorber
- Infused Shock Dispersion SHEET**
Advanced line of defense against shock impact helps dissipate and disperse force evenly
- Spongix**
Provides added resistance when met with high intensity force

FEATURES:-

- Layered with max-shock gel infused Tera-padding around the knuckles for max shock-absorption.
- Comes in elegant design with Quick EZ Duo-cuff elasticized wrist closure for wrist protection.
- Resilient maya Hide synthetic leather construction makes these gloves stubbornly durable and long-lasting.
- Moisture wicking Nylon mesh palm wicks away sweat and moisture, keeping hands odour free and fresh.
- "Machine-mold for hand adjustment enables better punching technique by assisting in fist closure.

SIZE CHART

FIGHTER WEIGHT (IN POUNDS)	FIGHTER WEIGHT (IN KILOGRAMS)	GLOVER WEIGHT (IN OUNCES)
80-100 LBS	37-46 KG	08 OZ
100-120 LBS	46-55 KG	10 OZ
120-140 LBS	55-64 KG	12 OZ
140-160 LBS	64-73 KG	14 OZ
160-180 LBS	73-82 KG	16 OZ

(110OZ RECOMMENDED FOR UPTO 14 YEARS OF AGE)

BGR-F11G

- Spongy Backtop FABRIC**
Backtop Laminated fabric with durability and responsiveness springs have sheet
- Polygonal Fusion FOAM**
Machine made interior polygonal cavities mold aligns itself to enhance the padding for heavy shock absorption
- DenZo-Tren FOAM**
Highly compressed layer provides added durability to impact resistance
- Infused Shock Dispersion SHEET**
Advanced line of defense against shock impact helps dissipate and disperse force evenly
- Spongix PADDING**
Provides added resistance when met with high intensity force

FEATURES:-

- Special Polygonal Diffusion mold effectively distributes shock-impact equal throughout patent pending glove.
- Highly compressed EVA-LUTION Foam padding absorbs shock-impact efficiently over knuckles and base of hand.
- supremo-shock Equilibrium sheet pressed against the exclusive polygonal Fusion mold provides the utmost shock-absorption against heavy Impacts CoolX ventilation mesh expels moisture build-up.
- New Quick-EZ hook & loop closure with extra-long strap provides added wr support and comfort adjustability.

SIZE CHART

FIGHTER WEIGHT (IN POUNDS)	FIGHTER WEIGHT (IN KILOGRAMS)	GLOVER WEIGHT (IN OUNCES)
100-120 LBS	46-55 KG	10 OZ
120-140 LBS	55-64 KG	12 OZ
140-160 LBS	64-73 KG	14 OZ
160-180 LBS	73-82 KG	16 OZ

(110OZ RECOMMENDED FOR UPTO 14 YEARS OF AGE)

BMR-1RK

BGR-S4BK

FEATURES:-

- Maya Hide leather bag mitt construction for comfortable, lasting performance.
- Supremo-Shock Foam absorbs shock and protects knuckles from the hardest of impacts.
- Curved design to reduce fatigue and to lower the risk of hand injuries.
- Quick-EZ Hook-and-Loop for a snug fit and added support around the wrists.
- Perforation for ventilation and maximum breathability.

SIZE CHART

FIGHTER WEIGHT (IN POUNDS)	FIGHTER WEIGHT (IN KILOGRAMS)	GLOVER WEIGHT (IN OUNCES)
100-120 LBS	46-55 KG	10 OZ
120-140 LBS	55-64 KG	12 OZ
140-160 LBS	64-73 KG	14 OZ
160-180 LBS	73-82 KG	16 OZ

(110OZ RECOMMENDED FOR UPTO 14 YEARS OF AGE)

FEATURES:-

- Handcrafted Boxing Gloves with genuine cowhide leather.
- Max-Shock Foam cushions without compromising on the punching of your fist.
- Gel-x gives the palm complete protective coverage that makes this glove ideal for kickboxing.
- The new TAKA stap system with elastic provides support and security to the wrists and allows for easy and quick wear and removal.
- Wick underlining that draws moisture away from the hand, keeping your palms and digits breezy and comfortable.

SIZE CHART

FIGHTER WEIGHT (IN POUNDS)	FIGHTER WEIGHT (IN KILOGRAMS)	GLOVER WEIGHT (IN OUNCES)
100-120 LBS	46-55 KG	10 OZ
120-140 LBS	55-64 KG	12 OZ
140-160 LBS	64-73 KG	14 OZ
160-180 LBS	73-82 KG	16 OZ

(110OZ RECOMMENDED FOR UPTO 14 YEARS OF AGE)



World can be tough and challenging, boxing will get your little one prepared if they ever need to.



JBR-80



- **Calibrated Impact Diffusion SHEET**
Multiple layers of foam with gel in-lying serves as added shock absorber
- **DenZo-Tron FOAM**
Highly compressed layer provides added durability & impact resistance
- **SpongeX PADDING**
Provides added resistance when met with high intensity force
- **Spongy Blacktop FABRIC**
Stacking Laminated fabric adds durability and complements springy foam sheet
- **Infused Shock Dispersion SHEET**
Advanced line of defense against shock impact helps dissipate and disperse force equally
- **EVA LUTION™ SHEET**
Advanced expanding foam absorbs and distributes impact evenly across surface

FEATURES:-

- Shell Shock Absorbent Foam.
- Quick EZ Hook-And-Loop Closure.
- Resilient Maya Hide Leather Construction.
- Cool X Ventilation Technology.
- EVA-Lution Foam Padding.

SIZE CHART

CHILD WEIGHT (IN POUNDS)	CHILD WEIGHT (IN KILOGRAMS)	GLOVE WEIGHT (IN OUNCES)
40-60 LBS	19-28 KG	04 OZ
60-80 LBS	28-37 KG	06 OZ





KBR-81BP



KBR-81PU



JBR-4E



JBR-4E



KBR-81GB

FEATURES:-

- Shell Shock Absorbent Foam.
- Quick EZ Hook-And-Loop Closure.
- Resilient Maya Hide Leather Construction.
- Cool X Ventilation Technology.
- EVA-Lution Foam Padding.

SIZE CHART

CHILD WEIGHT (IN POUNDS)	CHILD WEIGHT (IN KILOGRAMS)	GLOVE WEIGHT (IN OUNCES)
40-60 LBS	19-28 KG	04 OZ
60-80 LBS	28-37 KG	06 OZ



JBR-4B

FEATURES:-

- Shell Shock Absorbent Foam.
- Quick EZ Hook-And-Loop Closure.
- Resilient Maya Hide Leather Construction.
- Cool X Ventilation Technology.
- EVA-Lution Foam Padding.

SIZE CHART

CHILD WEIGHT (IN POUNDS)	CHILD WEIGHT (IN KILOGRAMS)	GLOVE WEIGHT (IN OUNCES)
40-60 LBS	19-28 KG	04 OZ
60-80 LBS	28-37 KG	06 OZ



MGR-190G

FEATURES:-

- 100% high quality PU leather.
- Breathable interior mesh.
- Triple density foam for a better shock Management, and a top hand protection.
- 100% full attached thumb.
- Large velcro enclosure with elastic for a better adjustment.

SIZE CHART

FIGHTER WEIGHT (IN POUNDS)		FIGHTER WEIGHT (IN KILOGRAMS)	GLOVER WEIGHT (IN OUNCES)
80-100	LBS	37-46 KG	08 OZ
100-120	LBS	46-55 KG	10 OZ
120-140	LBS	55-64 KG	12 OZ
140-160	LBS	64-73 KG	14 OZ
160-180	LBS	73-82 KG	16 OZ

(110OZ RECOMMENDED FOR UPTO 14 YEARS OF AGE)



MGR-190GG

FEATURES:-

- Lining 100% flex PU.
- Lining 70% PL 30% PU.
- Padding 90% high PU 10% Gel.



MGR-19LG

FEATURES:-

- Micro fiber material on the outer shell
- Shock-absorbing, high density foam core on the inners.
- Endurable, extra long lasting & they even help to prevent odors!

SIZE CHART

FIGHTER WEIGHT (IN POUNDS)		FIGHTER WEIGHT (IN KILOGRAMS)	GLOVER WEIGHT (IN OUNCES)
80-100	LBS	37-46 KG	08 OZ
100-120	LBS	46-55 KG	10 OZ
120-140	LBS	55-64 KG	12 OZ
140-160	LBS	64-73 KG	14 OZ
160-180	LBS	73-82 KG	16 OZ

(110OZ RECOMMENDED FOR UPTO 14 YEARS OF AGE)



MGR-19BG

FEATURES:-

- Cow leather for unparalleled performances and durability.
- Multi-layers compressed foam with wrist reinforcement to ensure maximum shock absorption and dispersion.
- Ergonomic shape for superior range of motion during clinch techniques.
- Breathable internal lining to ease sweat evacuation and keep your gear fresh.
- Mesh panel under the fist and micro-perforations to regulate thermal heat.
- Elastic velcro wrist.



ARG-20CB

FEATURES:-

- Hand-made, crafted from the softest vinyl leather/PU.
- Shock absorbing holes in the palm area provides increased hygiene efficiency from unwanted odors and bacteria which keep your fighters hands dry and fresh.
- SNUG FIT wrist wraps.
- Ultra-comfort with unique mesh lining and extra padding.
- Suitable for boxing, sparring, punching or training.
- Perfect for 4 years kids to a young man or a woman.

SIZE CHART

FIGHTER WEIGHT (IN POUNDS)	FIGHTER WEIGHT (IN KILOGRAMS)	GLOVER WEIGHT (IN OUNCES)
40-60 LBS	19-28 KG	04 OZ
60-80 LBS	28-37 KG	06 OZ
80-100 LBS	37-46 KG	08 OZ
100-120 LBS	46-55 KG	10 OZ
120-140 LBS	55-64 KG	12 OZ
140-160 LBS	64-73 KG	14 OZ
160-180 LBS	73-82 KG	16 OZ

(110OZ RECOMMENDED FOR UPTO 14 YEARS OF AGE)



ARG-20CG

FEATURES:-

- 100% cowhide leather.
- Velcro wrist strap as well as an attached thumb for extra safety & comfort.
- Suitable for boxing, sparring, punching or training.
- Perfect for 4 years kids to a young man or a woman.



MGR-19LG

FEATURES:-

- 100% cowhide leather.
- Velcro wrist strap as well as an attached thumb for extra safety & comfort.
- Suitable for boxing, sparring, punching or training.
- Perfect for 4 years kids to a young man or a woman.



MGR-19BG

FEATURES:-

- 100% cowhide leather.
- Velcro wrist strap as well as an attached thumb for extra safety & comfort.
- Suitable for boxing, sparring, punching or training.
- Perfect for 4 years kids to a young man or a woman.

SIZE CHART

FIGHTER WEIGHT (IN POUNDS)	FIGHTER WEIGHT (IN KILOGRAMS)	GLOVER WEIGHT (IN OUNCES)
40-60 LBS	19-28 KG	04 OZ
60-80 LBS	28-37 KG	06 OZ
80-100 LBS	37-46 KG	08 OZ
100-120 LBS	46-55 KG	10 OZ
120-140 LBS	55-64 KG	12 OZ
140-160 LBS	64-73 KG	14 OZ
160-180 LBS	73-82 KG	16 OZ

(110OZ RECOMMENDED FOR UPTO 14 YEARS OF AGE)



ARG-20CB

FEATURES:-

- Finished with the sleek carbon fibre and camo print.
- Combination of high grade cowhide leather and Syntec.
- 5 inch keyhole opening to easily slip on.
- Thick 3 inch velcro strap for wrist support.
- Injection moulded foam insert.
- Attached thumb for protection.



ARG-20CG

FEATURES:-

- Closure: Velcro.
- Disciplines: Boxe, Kick Boxing, Muay Thai.
- Padding: 70% flex PU, 30% basic PU.
- Sleeve: PU.
- Hand back and palm material: PU.



MGR-19LG

FEATURES:-

- Closure: Velcro.
- Disciplines: Boxe, Kick Boxing, Muay Thai.
- Padding: 70% flex PU, 30% basic PU.
- Sleeve: PU.
- Hand back and palm material: PU.
- Gender: Unisex.



MGR-19BG

FEATURES:-

- Closure: Velcro.
- Disciplines: Boxe, Kick Boxing, Muay Thai.
- Padding: 70% flex PU, 30% basic PU.
- Sleeve: PU.
- Hand back and palm material: PU.

SIZE CHART

FIGHTER WEIGHT (IN POUNDS)	FIGHTER WEIGHT (IN KILOGRAMS)	GLOVER WEIGHT (IN OUNCES)
40-60 LBS	19-28 KG	04 OZ
60-80 LBS	28-37 KG	06 OZ
80-100 LBS	37-46 KG	08 OZ
100-120 LBS	46-55 KG	10 OZ
120-140 LBS	55-64 KG	12 OZ
140-160 LBS	64-73 KG	14 OZ
160-180 LBS	73-82 KG	16 OZ

(110OZ RECOMMENDED FOR UPTO 14 YEARS OF AGE)

SIZE CHART

FIGHTER WEIGHT (IN POUNDS)	FIGHTER WEIGHT (IN KILOGRAMS)	GLOVER WEIGHT (IN OUNCES)
40-60 LBS	19-28 KG	04 OZ
60-80 LBS	28-37 KG	06 OZ
80-100 LBS	37-46 KG	08 OZ
100-120 LBS	46-55 KG	10 OZ
120-140 LBS	55-64 KG	12 OZ
140-160 LBS	64-73 KG	14 OZ
160-180 LBS	73-82 KG	16 OZ

(110OZ RECOMMENDED FOR UPTO 14 YEARS OF AGE)

BE NOIR UP THE GAME



MGR-19BG



FEATURES:-

- Game changer.
- Shock Absorption.
- Quick-EZ secure fit.
- Knuckle protection.
- Bag & pad training.
- Triple layered padding.
- Air aeration technology.
- Reinforced double stitching.

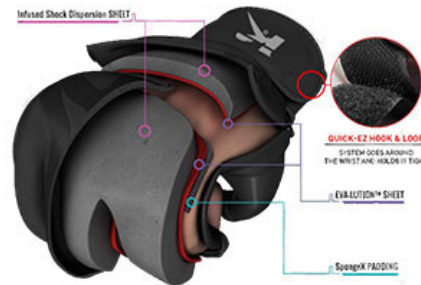

- Advanced line of defense against shock/impact helps dissipate and disperse force evenly
- Advanced expanding foam absorbs and distributes impact evenly across surface
- Provides added resistance when met with high-intensity force



SIZE CHARTS	S	M	L	XL
-------------	---	---	---	----

Hand Circumference	15cm-17cm	18cm-20cm	21cm-23cm	24cm-25cm
--------------------	-----------	-----------	-----------	-----------

SMALL & MEDIUM SIZES RECOMMENDED FOR UP TO 14 YEARS OF AGE.



MMA-GT7



FEATURES:-

- Durable and long-lasting.
- Polymax contoured tri-slab Pc3 padding protection against shock-impact.
- Quick-EZ hook and loop gives a comfortably snug fit and supports the wrists.
- Advanced inner-lining and moisture wicking microfabric.
- Dcut palm-side design promotes moisture escape while offering better grip and an added thumb padding.
- Available colors: **Pink, Purple, Green, Golden, Red, Blue**

SIZE CHARTS	S	M	L	XL
1 Hand Circumference	15cm-17cm	18cm-20cm	21cm-23cm	24cm-25cm

SMALL & MEDIUM SIZES RECOMMENDED FOR UP TO 14 YEARS OF AGE.



FEATURES:-

- Durable and long-lasting.
- Polymax contoured tri-slab Pc3 padding protection against shock-impact.
- Quick-EZ hook and loop gives a comfortably snug fit and supports the wrists.
- Advanced inner-lining and moisture wicking microfabric.
- Dcut palm-side design promotes moisture escape while offering better grip and an added thumb padding.
- Available colors: **Pink, Purple, Green, Black, Red, Blue**

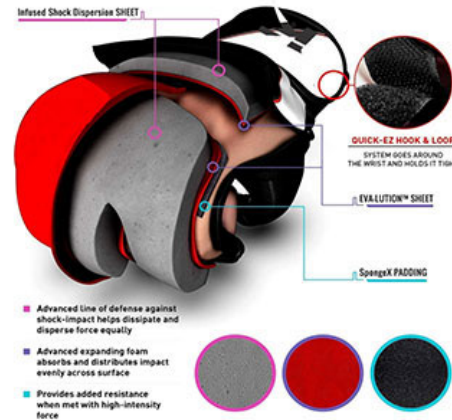

SIZE CHARTS	S	M	L	XL
1 Hand Circumference	15cm-17cm	18cm-20cm	21cm-23cm	24cm-25cm

SMALL & MEDIUM SIZES RECOMMENDED FOR UP TO 14 YEARS OF AGE.



MMA-BT6



FEATURES:-

- Made of durable sturdy hide synthetic construction for resiliency and longevity.
- For added stability Gloves are made of cross directional system that reinforces the strap hence protecting your wrist.
- Wrap around wrist strap with hook-and-loop closure.
- E.cool technology-moisture absorbing lining to keep you hands dry.
- Articulated finger ridges for ease of movment.

SIZE CHARTS	S	M	L	XL
1 Hand Circumference	15cm-17cm	18cm-20cm	21cm-23cm	24cm-25cm

SMALL & MEDIUM SIZES RECOMMENDED FOR UP TO 14 YEARS OF AGE.



FEATURES:-

- Durable and long-lasting.
- Polymax contoured tri-slab Pc3 padding protection against shock-impact.
- Quick-EZ hook and loop gives a comfortably snug fit and supports the wrists.
- Advanced inner-lining and moisture wicking microfabric.
- Dcut palm-side design promotes moisture escape while offering better grip and an added thumb padding.
- Available colors: **Pink, Purple, Green, Yellow, Red, Blue**



SIZE CHARTS	S	M	L	XL
1 Hand Circumference	15cm-17cm	18cm-20cm	21cm-23cm	24cm-25cm

SMALL & MEDIUM SIZES RECOMMENDED FOR UP TO 14 YEARS OF AGE.



Weightlifting

Gym Training

Fitness

FITNESS ONLY

PRESSURIZED BRACERS IMPROVE THE POWER



FEATURES:-

- Interpretation of Materials.
- **Microfiber:** Which can reduce the friction of the appliance to the user's palm.
- **Lycra:** The Lycra is a light and breathable material.
- Sturdy wrists protection structure.
- Reusable velcro.
- Towels on the thumb.
- Soft sponge pads.
- Breathable and lightweight.
- Easy to put on and take off.

Precautions:

- Preferred washed by hand. you only need to soak the gloves with soap, then rub and wash, dry it in the shade.
- If washed by machine, it is better to put the gloves into the laundry bag to reduce the likelihood of deformation.
- Never use hot water, bleach, and other strong acid wash, and do not bask in the sun.

HAND CIRCUMFERENCE

	IN	CM
S	6.60"-7.50"	17-19cm
M	7.50"-8.30"	19-21cm
L	8.30"-9.09"	21-23cm
XL	9.09"-9.88"	23-25cm
XXL	9.88"-11.1"	25-28cm

HOW TO MEASURE THE RIGHT SIZE

1. Find your palm.
2. Measure the right size.
3. Compare your palm's circumference with the size chart and choose the right one.





MGC-19

Materials:

- Outer Fabric: Polyurethane.
- Inner Fabric: 70% Polyester +30% Polyurethane.
- Padding: 50% high PU + 50% basic PU.
- Padding: Flex-PU Gel.
- Closure: Velcro
- Gender: Unisex



MGN-X6

FEATURES:-

- Double down on hand-protection gloves.
- Neoprene and 4 way breathable stretch fabric.
- Shell-shock gel Equilibrium Sheet.
- EVA padding foams a wall of shock-absorbency.
- Quick-EZ Hook and Loop with elastic strap on palm.



	SMALL	MEDIUM	LARGE	X-LARGE
A HAND circumference	15cm - 17cm	18cm - 20cm	21cm - 23cm	24cm - 25cm

Small & Medium size recommended for 14 years old



QUICK-EZ HOOK & LOOP



HWG-30

FEATURES:-

- Half Finger Design.
- Woven Carbon Fiber.
- Shell-Shock Padding.
- Wrap around Design.
- Thermal Regulation Technology.
- Shell Shock Absorbing Padded Knuckle.
- 75 cm Long Wrap around cotton Bandage.



SIZE (IN CM)	S	M	L	XL
A	17-19	19-21	21-23	23-25

IMPORTANT:

- ▲ Measure the full circumference around center of palm.
- ▲ There might be variance of 0.5cm - 0.9cm due to hand-made construction and nature of material but this shouldn't affect the actual size.
- ▲ This guide is an estimate only can't account for individual preferences.



HW-EP



HW-EB

FEATURES:-

- Built using a woven carbon fibre fabric for max strength and resilience
- Ayz-F elastic for unbeatable security and support for bones
- Half-finger cut design to ensure a strong grip.



SIZE CHART

SIZE	A	B
S	17cm - 20cm	18cm
M	20cm - 23cm	19cm
L	23cm - 26cm	20cm
XL	26cm - 29cm	21cm

IMPORTANT:

- ▲ There might be variance of 0.5 cm in every measurement.
- ▲ If measurements are in between 2 sizes, choose a lower size.



HW-ESB



HW-ESBK



HW-ESR



HW-EBSP

FEATURES:-

- Elastic Carbon Fiber Hand Wrap with hook and loop closure.
- Extra thick carbon fiber woven material offers even better protection than regular hand wraps.
- hook and loop closure at the other end allowing you to secure the wraps, It's ideal for exceptional athletes.
- The wraps are approximately 4.5 metres long.
- Hook and loop closure for easy on and off.

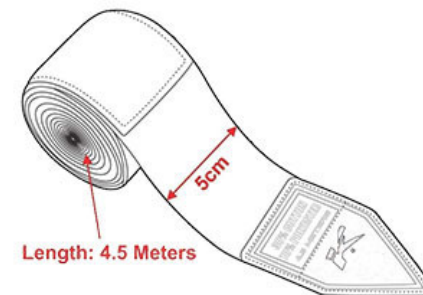

Length: 4.5 Meters



WLG-05BK

FEATURES:-

- Breathable Nylon Glove Body.
- Enhanced Silicone Non-Slip Grip.
- Flexible velcro Closure.
- Adjustable Comfort Fit.
- Sweat Resistant.
- Unisex (Men and Women).



This palm protection is especially important for hands put under pressure such as:



How to Measure Your Hand Glove Size

For a correct sizing, measure the circumference of your hand at the knuckles. Do not include the thumb!

SIZE	MEASUREMENT
XS	6" - 6.9"
S	6.9" - 7.7"
M	7.7" - 8.7"
L	8.7" - 9.4"
XL	9.4" - 10.3"



Designed to Fit Both Male ♂ & ♀ Female

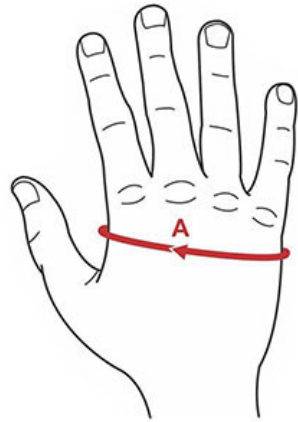

WLG-19B

FEATURES:-

- Quick EZ Grip.
- Pull tab design.
- Durable Amara fabric.
- Stretchable Lycra fabric.
- Reduces Blisters, Cuts and Nicks.
- 3mm perforated palm padding.
- Goat Leather for Finger Webbing.
- Breathable, lightweight.

SIZE (IN CM)	S	M	L	XL	XXL
A	17-19	19-21	21-23	23-25	25>



WLG-20W

FEATURES:-

- High-quality materials such as Lycra, authentic leather, and suede.
- 3mm padding under suede grip alleviates pressure against heavy weight and makes your grip stronger.
- Use for a range of activities such as weightlifting, cycling, rowing etc.
- Patent pending Gym gloves that are made with maximum comfortability in mind.

SIZE (IN CM)	S	M	L
A	16-18	18-20	20-22



GYM-F3K1

FEATURES:-

- Lycra Fabric is thin, breathable & hugs the hand comfortably.
- Rubberized M-grip on the palm and fingers ensure maximum zero-slip grip.
- Nylon mesh throughout the palm traps cool air while evacuating heat and moisture.
- Lycra finger webbing accentuates hand mobility while towel suede manages sweat build-up.
- Quick-EZ hook and loop strap along with rubberized pull-fins ensures easy on/off application.



SIZE (IN CM)	S	M	L	XL	XXL
A	15-17	18-20	21-23	24-25	26 >

SMALL & MEDIUM SIZES RECOMMENDED FOR UP TO 14 YEARS OF AGE.



WLG-15

Ventilated Pockets

Promotes necessary air circulation throughout all areas.

Durable Leather

Provides long lasting durability and is workout safe.

Velcro Strap

Wide Velcro latch is diagonal, providing flexibility and movement.



Breathable Material

Soft, breathable fabric prevents sweat from accumulating.

Double Stitched

Double stitched to prevent easy breakage and maintain form.

Elastic Band

Fitted elastic band helps to avoid slippage and workout discomfort.

Flexible Material

Supports full range of motion and comfort while gripping.

Leather Reinforce

Provides sufficient protection and a stronger hold.

Thumb Protection

Offers ample room for thumb rotation and movement.



Maximum Dexterity

Ideal finger length for the most accurate feel and control.

Machine Washable

Durable materials allows for a thorough clean in the washing machine.

Superior Cushioning

Padded surface supports hands during strenuous activity.

SIZE (IN CM)	S	M	L	XL	XXL
A	15-17	18-20	21-23	24-25	26 >

SMALL & MEDIUM SIZES RECOMMENDED FOR UP TO 14 YEARS OF AGE.



WSTP-10C



WSTP-10BK



WSTP-10O



WSTP-10P



WSTP-10B

FEATURES:-

- Super heavy duty weight lifting straps Katana.
- Comfortable oversized neoprene padding on contact areas.
- Locks in grip while lifting heavy with no-slip ridged woven cotton.
- Fully adjustable to fit all wrists & hands - 23in length.
- Includes 2 straps (1 pair) - left right configuration.



WSTP-10R

FEATURES:-

- Super heavy duty weight lifting straps Katana.
- Comfortable oversized neoprene padding on contact areas.
- Locks in grip while lifting heavy with no-slip ridged woven cotton.
- Fully adjustable to fit all wrists & hands - 23in length.
- Includes 2 straps (1 pair) - left right configuration.



HG-T1W



SIZE CHART

SIZE	A
S	61cm
M	63cm
L	65cm
XL	67cm

IMPORTANT:

- ▲ There might be variance of 0.5 cm in every measurement.
- ▲ If measurements are in between 2 sizes, choose a lower size.

FEATURES:-

- High-quality Maya Hide leather shields the well-built interior of these triple padded head guards.
- The shock-absorbent padding on the inside is lined with a slab of Shell-Shock gel for max shock absorption.
- Optional removable face grill is made of high quality lightweight polymerto protect the head entirely
- Compressed triple slab padding with shell shock gel lining between each slab maximize shock absorbcency
- Quick-EZ hook & loop closure conforms to head shape without budging or slipping out of place.
- **Note:** Non Washable
- Assembled Product Dimensions (LxWxH) 11.79 x 8.25 x 11.00 inches.



HGL-T1W



HGL-T5M



FEATURES:-

- made from authentic top grain cowhide leather that protects the shock absorbent content of this head guard.
- Hi-tech shock absorbent mould consolidates shock-impact and is backed by slab of supremo shock foam.
- Non-budge design encapsulates the face and head all the way till the checks for efficient protection.
- Handcrafted and stitched for professional boxing sparring Designed to keep your head in the game.
- Top/rear lace design ensures easy adjustment and a snug fit. Amara fabric inner wicks sweat and feels pleasant to the skin.

SIZE (IN CM)	S	M	L	XL
A	< 53	54-55	56-57	58 >

(S & M SIZES ARE RECOMMENDED FOR UPTO 14 YEARS OF AGE)

FEATURES:-

- Maya Hide leather construction for outstanding durability.
- Shell-Shock Gel padded for comfort and shock resistance.
- G-Core technology for zero impact feel during sparring and training.
- Face bar for pro level protection in the ring.
- R-lock head guard locking system for the ultimate security.

SIZE (IN CM)	S	M	L	XL
A	< 53	54-55	56-57	58 >

(S & M SIZES ARE RECOMMENDED FOR UPTO 14 YEARS OF AGE)



HGL-O1L



HGL-O2L



FEATURES:-

- Made from authentic top grain cowhide leather that protects the shock-absorbent content of this head guard.
- Hi-tech shock absorbent mould consolidates shock-impact and is backed by slab of Supremo Shock foam.
- Non-budge design encapsulates the face and head all the way till the cheeks for efficient protection.
- Handcrafted and stitched for professional boxing sparring.
- Designed to keep your head in the game.
- Top/rear lace design ensures easy adjustment and a snug fit.
- Amara fabric inner wicks sweat and feels pleasant to the skin.



FEATURES:-

- Pro sparring head gear with cheek protection provide advanced shock absorbing against highimpact shots.
- High-compressed Eva foam padding is layered to consolidate shock-impavtsafely within the gurard.
- Handstitched and crasted using a unique moulding pattern for durability and prefect zero-budge grip.
- Polyester threading throughout the guard ensures unbreakable durability.
- Pleasant Amara fabric inner along with strap under chin allows zero.

SIZE (IN CM)	S	M	L	XL
A	< 53	54-55	56-57	58 >

(S & M SIZES ARE RECOMMENDED FOR UPTO 14 YEARS OF AGE)

SIZE (IN CM)	S	M	L	XL
A	< 53	54-55	56-57	58 >

(S & M SIZES ARE RECOMMENDED FOR UPTO 14 YEARS OF AGE)



HGK-J1B



HGK-J1B



FEATURES:-

- Maya Hide Leather Boxing MMA Head Guard.
- Inner liner is made with soft a Non-slip material which wicks moisture.
- Combination of soft and multi-layered foam padding.
- An easy access rear entry system is used making usage comfortable.
- Fully adjustable hook and loop straps on top and behind.
- **Size:** One size.

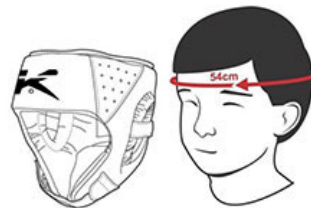
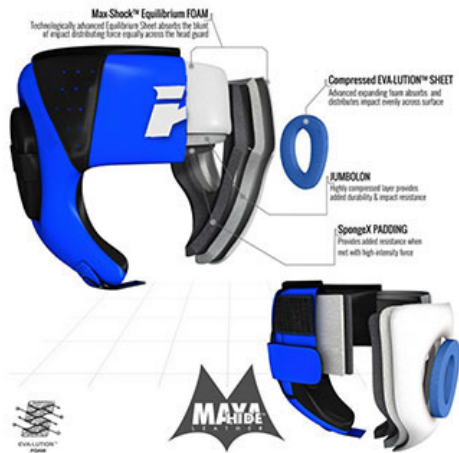

FEATURES:-

- Maya Hide Leather Boxing MMA Head Guard.
- Inner liner is made with soft a Non-slip material which wicks moisture.
- Combination of soft and multi-layered foam padding.
- An easy access rear entry system is used making usage comfortable.
- Fully adjustable hook and loop straps on top and behind.
- **Size:** One size.

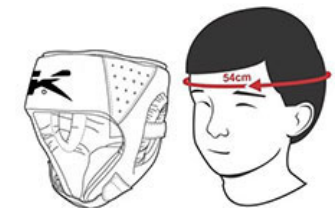



MGL-20

MOUTH GUARD FITTING INSTRUCTIONS

STEP 1

Place 3-4 inches of boiled water in the bowl. After 20 seconds place the MGL Mouth Guard



STEP 3

Use fingers to press edges of mouth guard into teeth and gums line through lips and cheeks for about 20 seconds.



STEP 2

Place the mouth guard in for about 70-80 seconds by max. Carefully remove the mouth guard and cool it under tap water for 1-2 seconds



STEP 4

Remove it and place it under cold water for 30 seconds. Mouth guard is ready to use.



FEATURES:-

- Poly Gel latex-free gum shield, defends your teeth from any contact sports.
- Gel fit lining for maximum shock absorption.
- Tri-Flow perforations allows to escape the air and makes breathe easier under strains.
- Fits best for adults (+12) & youngsters (-12) alike.
- NOT RECOMMENDED WITH BRACES.
- NEVER CHEW YOUR MOUTH GUARD.



CG-BR1



CG-T2



FEATURES:-

- Full chest & belly coverage for maximum abdominal protection.
- Winged design also covers obliques from side strikes.
- Thick 2.5" padding with integrated layer of impact Gel
- Centered 3" power core for additional sternum and belly coverage.
- Fully adjustable back strap system to fit any body type.
- Ergonomic design hugs body to allow maximum mobility.
- Premium, thick synthetic leather body and highest quality materials.
- **Sizes:** One Size-Fully Adjustable.



FEATURES:-

- Patented Maya Hide leather is armour in-itself and will last you a career.
- 18mm EVA-LUTION with 24MM Foam lamination offers a barrage of shock-absorbent padding.
- TKD Chest guard straps with elastic incorporates a hook and loop with nylon strap, ensuring an efficient and comfortable fit.
- T-3 triple Nylon stitching and PU piping ensures a stubbornly durable product that lasts you a decisive career.
- Reversible design can be used for red or blue.
- **Sizes:** One Size-Fully Adjustable.



ABD-L1



FEATURES:-

- Designed with cowhide leather covering groin and kidney areas.
- A special Retrico™ lining for improved support.
- With Shell-Shock™ Gel incorporated for wrap-around protection.

SIZE CHART

SIZE	Waist (A)	LENGTH (B)
S	78cm - 84cm	31cm
M	84cm - 90cm	32cm
L	90cm - 96cm	33cm
XL	96cm - 102cm	34cm

IMPORTANT:

- ⚠ There might be variance of 0.5 cm in every measurement.
- ⚠ If measurements are in between 2 sizes, choose a lower size.



ABD-O1



FEATURES:-

- Tough authentic top-grain cowhide leather is built to last you a career all the way to your first champion rounds Handcrafted and stitched using nylon threads for unbeatable durability.
- Supremo-Shock Foam™ dissipates shock and shields the vitals: groin, abdomen and kidney area from body shots.
- Hard shell polymer cup with double layered closed-cell foam for added groin protection.
- Compartment holds ample room for jock-strap with enough space for a doubled-down cup.
- Ergonomically designed shape for the best fit and comfort during training.

SIZE CHART

SIZE	Waist (A)	LENGTH (B)
S	78cm - 84cm	31cm
M	84cm - 90cm	32cm
L	90cm - 96cm	33cm
XL	96cm - 102cm	34cm

IMPORTANT:

- ⚠ There might be variance of 0.5 cm in every measurement.
- ⚠ If measurements are in between 2 sizes, choose a lower size.





ABD-L1



FEATURES:-

- Handcrafted with tough Maya Hide leather for long-lasting life and durability.
- Supremo Foam technology dissipates force of shock upon impact, efficiently guarding the vital areas such as the groin and kidneys.
- Double layered closed cell foam with hard shell plastic cup does away with unfortunate shots to region.
- Handy cup compartment which allows you to use additional cups for double the security.
- Ergonomically designed shape for the best fit and comfort during training with compartment to conveniently place a groin cup (CUP NOT INCLUDED).

SIZE CHART

SIZE	Waist (A)	LENGTH (B)
S	78cm - 84cm	31cm
M	84cm - 90cm	32cm
L	90cm - 96cm	33cm
XL	96cm - 102cm	34cm

IMPORTANT:

- ⚠ There might be variance of 0.5 cm in every measurement.
- ⚠ If measurements are in between 2 sizes, choose a lower size.



ABD-X3



FEATURES:-

- Removable Shell Shock GEL lined groin cup can comfortably be placed without hindering movement.
- Special foam layer enhances padding and resistance against impact.
- QD-1 lining with sweat wicking lining keeps regions dry, comfy and reduces sweat build-up.
- Lightweight construction with breathability a barely-there feel. Elasticated jock strap design and wide belt for a secure and comfortable fit.



SIZE CHART

SIZE	A
S	24" - 28"
M	28" - 32"
L	32" - 36"
XL	36" - 40"

IMPORTANT:

- ⚠ There might be variance of 0.5 cm in every measurement.
- ⚠ If measurements are in between 2 sizes, choose a lower size.



ABD-X1

FEATURES:-

- Maya Hide™ leather makes this boxing groin guard your number one partner for kidney, liver, and groin protection.
- Supremo-Shock Foam™ promises advanced impact breaking shock-absorbency.
- Double layered closed-cell foam with hard shell polymer cup for solid groin protection.
- Cup compartment can fit an extra cup to double down on safety and confidence.
- Adjustable strap system with laces and elastic band for the perfect, snug fit.
- Assembled Product Dimensions (L x W x H) 11.00 x 9.04 x 2.99 Inches.



AVAILABLE SIZES: S, M, L & XL
S & M SIZES ARE RECOMMENDED FOR UP TO 14 YEARS OF AGE



ABD-CX



FEATURES:-

- Polycarbonate Construction Material.
- Shell Shock gel.
- Rubberized Lining.
- Ventilated Holes.
- 4-Way Stretch Panel.
- Unrestricted Movement.





FEATURES:-

- Carbon Fiber fabric that offer better for split, tear and crack resistance.
- High density padding protects your shin effectively without conceding any power.
- Shell Shock gel padding makes these shin guards almost invincible, allowing you to dish out some major force with full conviction.
- Close-fitting, form-fitting, and breathable firmness in fabric preserves shin strength.
- These guards spring back even after multiple washings.

SIZE CHART

SIZE	SHIN LENGTH (A)	INSTEP LENGTH (B)	USER HEIGHT
S	32cm	15cm	134 - 152 cm
M	34cm	16cm	152 - 170 cm
L	36cm	17cm	170 - 180 cm
XL	38cm	18cm	180 cm +

IMPORTANT:

- ⚠ There might be variance of 0.5 cm in every measurement.
- ⚠ If measurements are in between 2 sizes, choose a lower size.

FEATURES:-

- Carbon Fiber fabric that offer better for split, tear and crack resistance.
- High density padding protects your shin effectively without conceding any power.
- Shell Shock gel padding makes these shin guards almost invincible, allowing you to dish out some major force with full conviction.
- Close-fitting, form-fitting, and breathable firmness in fabric preserves shin strength.
- These guards spring back even after multiple washings.

SIZE CHART

SIZE	SHIN LENGTH (A)	INSTEP LENGTH (B)	USER HEIGHT
S	32cm	15cm	134 - 152 cm
M	34cm	16cm	152 - 170 cm
L	36cm	17cm	170 - 180 cm
XL	38cm	18cm	180 cm +

AVAILABLE SIZES: S, M, L & XL

S & M SIZES ARE RECOMMENDED FOR UP TO 14 YEARS OF AGE





SG-S3B



FEATURES:-

- Comfort and shock-absorbency in the knee cap – throw knees with confidence.
- Perfect for Muay Thai kickboxing or MMA training.
- EVA padded foot instep protects the most fragile part of your leg – the foot.
- Sweat wicking compressional hosiery design is convenient in use, and comfortable to wear.
- Strap Quick-Ez™ hook & loop and get to training instantly with reduced risk of injury.

SIZE CHART

SIZE	(A)	(B)
S/M	52cm	15cm
L/XL	54cm	16cm

(SMALL / MEDIUM SIZES RECOMMENDED FOR UPTO 14 YEARS OF AGE)

IMPORTANT:

- ▲ There might be variance of 0.5 cm in every measurement.
- ▲ If measurements are in between 2 sizes, choose a lower size.

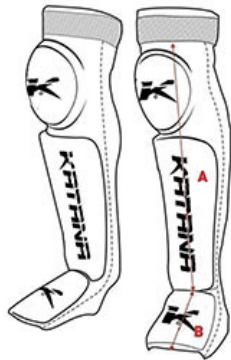

SG-T6BL



FEATURES:-

- Neoprene gel shin pads with instep foot protectors.
- Unique stretchy material to ensure a secure fit.
- The shock-absorbing technology fully protects from injury.
- Exclusive reinforced stitching ensures maximum durability and resilience.
- Offers security for your shin and instep with the impact distributing material.



SIZE CHART

SIZE	SHIN LENGTH (A)	INSTEP LENGTH (B)
S/M	29cm	15cm
L/XL	30cm	16cm

IMPORTANT:

- ▲ There might be variance of 0.5 cm in every measurement.
- ▲ If measurements are in between 2 sizes, choose a lower size.



SGR-T7R



FEATURES:-

- Made using highly durable Maya Hide leather for an unbreakable, long-lasting product.
- Multi-layered padding absorbs the harshest of impacts with equal shock distribution.
- Neo-1 based embedded neoprene stretch material comfortably aligns against the body.
- QD-2 inner lining to wick away sweat, keeping the skin fresh.
- Cross-over strapping system locks pad down in place with zero budge.

SIZE CHART

SIZE	SHIN LENGTH (A)	INSTEP LENGTH (B)	USER HEIGHT
S	32cm	17.5cm	134 - 152 cm
M	34cm	18.5cm	152 - 170 cm
L	36cm	19.5cm	170 - 180 cm
XL	38cm	20.5cm	180 cm +

IMPORTANT:

- ▲ There might be variance of 0.5 cm in every measurement.
- ▲ If measurements are in between 2 sizes, choose a lower size.



SGR-T6BL

FEATURES:-

- Lightweight nylon and plastic outer for easy movement and durability.
- Shell Shock GEL™ for cushioning and even impact distribution.
- Supremo-Shock Foam™ padding to effectively absorb shock.
- QD-1™ lining with moisture wicking abilities to keep you dry.
- Quick-EZ™ hook & loop closure for a snug fit and zero budge.
- Non slip and moulded for unbeatable in-ring comfort.



FEATURES:-

- Convenient Adjustable strap.
- Antimicrobial properties.
- Made from a Cow hide leather.
- Hook and-loop straps really secure.
- Wraparound coverage with three layer contoured Gel integrated padding.
- Articulated Gel integrated cover ankle instep for added comfort enhanced performance.
- Secures the guard to the foot shin even through the most intense scrambles.
- Engineered for MMA.

SIZE CHART

SIZE	SHIN LENGTH (A)	INSTEP LENGTH (B)	USER HEIGHT
S	32cm	17.5cm	134 - 152 cm
M	34cm	18.5cm	152 - 170 cm
L	36cm	19.5cm	170 - 180 cm
XL	38cm	20.5cm	180 cm +

IMPORTANT:

- ▲ There might be variance of 0.5 cm in every measurement.
- ▲ If measurements are in between 2 sizes, choose a lower size.



SGR-T2BW



KG-BL



KG-BK

FEATURES:-

- Made from resilient carbon fibre fabric, woven for added strength and performance.
- Padded low profile knee area for maximum mobility during training and workouts.
- Elastic which moulds to the contour of your leg for a snug fit.
- ventilation technology to keep your skin dry and healthy.
- lining with moisture wicking to prevent sweat or odour build up.
- These guards spring back even after multiple washings.

- **Size Guide:**
Measure the circumference of your knee 2 inches below the centre.

Small: 30 - 33cm
Medium: 33 - 35cm
Large: 35 - 38cm
X-Large: 38 - 40cm



AGP-A1M

FEATURES:-

- 100% polyester
- This ankle supports comfortably fit with or without socks and does not lead any restriction in movement.
- Best quality material is used for this soft and comfortable ankle supports.
- Ankle support exerting regular compression to the heel and ankle through decreasing the risk of any injuries during work out or training.
- FOR ATHLETIC PEOPLE -Boxing, MMA, Muay Thai, Football, Basketball, Volleyball offering the feet comfort and best protection.

Ankle Supports Size Chart (Based on shoe sizes)

Sizing	Small	Medium	Large	X-Large
Men's	5-7	8-10	11-13	13+
Women's	6-8	9-11	12-14	14+

*Standard Adult Sizes



HYP-EB



FEATURES:-

- Elbow Featuring Dri-Fit moisture-management with soft synthetic.
- Cross-over hook and loop strapping system for locking down the pad.
- Extra Light Carbon Fiber Padding ensures optimal durability.
- The Low-profile construction Pads designed to hold Elbow Pads firmly.
- These guards spring back even after multiple washings.

SIZE CHART

WEARER SIZE	USER HEIGHT
S/M	134-170
L/XL	170-180+



HYP-FUM

FEATURES:-

- Elbow Featuring Dri-Fit moisture-management with soft synthetic.
- Cross-over hook and loop strapping system for locking down the pad.
- Extra Light Carbon Fiber Padding ensures optimal durability.
- The Low-profile construction Pads designed to hold Elbow Pads firmly.
- These guards spring back even after multiple washings.

SIZE CHART

WEARER SIZE	USER HEIGHT
S/M	134-170
L/XL	170-180+

FEATURES:-

- Compressed contoured foam padded elbow repels shots when blocking and absorbs impact when blocking against kicks to the ribs or shots to the body.
- Shock resistant EVA slab blocks and absorbs stray shots that land on the forearm – perfect for kickboxing or boxing training.
- The protective arm ends with a foam padded EVA inner glove that conveniently slips under the glove of choice.
- Hosiery retains memory, wicks sweat and offers compressional feel when worn.
- Strap in the Quick-Ez™ hook & loop with ease and focus more on training than being hurt.

SG-S3B

IMPORTANT:

- ▲ There might be variance of 0.5 cm in every measurement.
- ▲ If measurements are in between 2 sizes, choose a lower size.



WR-A1M



FEATURES:-

- High elasticity Polyester material to allow for either a loose or snugger fit without cutting off circulation and permeability is strong;
- Adjustable size fit Gym, Crossfit Training, Weight Lifting, Powerlifting, Pushups (all types) Planks, and burpees all of which were starting to take a toll your wrist;
- Sold as a pair; Each wrap has a thumb loop for security and support, you can be underneath the wraps if you do not need it;
- Long and wide size(17.2 by 3 inch);



KW-P2M

FEATURES:-

- Made of heavy-duty Poly-Cotton elastic. One size fits all.
- These Knee Wraps are considered to provide maximum support and comfort.
- Perfectly developed for the hard-core bodybuilding, weight-lifter or power-lifter alike.
- This is a pair of cotton elastic knee wraps; each wrap is about 2M long and 3 Inch wide
- Offers cryotherapy and great compression for the knee.
- Provide unrivaled guard and support for even the most grueling of heavy leg workouts.
- Extreme tight rubber standard knee wraps designed for the ultimate rebound.
- Designed to perfectly grip the skin which eradicates the necessity for chalking the knees.
- Ideal cold pack therapy for best recovery of severe knee injuries.





TG-R1B



FEATURES:-

- Maya Hide leather makes these Taekwondo gloves indestructibly resilient.
- EVA-LUTION foam padding absorbs heavy shock-impact to protect the hands.
- 4-way breathable stretch fabric provides breathability and elastic hand conformity for better blood-flow and moisture wicking ability.
- Neoprene built Quick-EZ hook and loop offers easy application and elasticated wrist support.
- Inner-grip hose assists with punch formation and punching technique.
- S & M SIZES ARE RECOMENDED FOR UPTO 14 YEARS OF AGE.

SIZE CHART

Size	A
S	15-17 cm
M	18-20 cm
L	21-23 cm
XL	24-25 cm



SC-M1RM



FEATURES:-

- Made with durable Maya Hide Leather.
- Designed to preserve and protect fist form.
- Shock-resistant TKD gloves that dissipate blunt impact.
- Elasticity that conforms to hands for minimal budge and snag.
- Adjustable strap with Quick-EZ hook-and-loop feature.

Size Chart

114-140 LBS	52-64 KG	12 OZ
161-180 LBS	74-82 KG	16 OZ

FEATURES:-

- Made from tough Maya Hide™ leather for the ultimate armour and protection.
- Unique moulded design for even impact distribution throughout the shin guards.
- Infused dispersion sheet and EVA-LUTION FOAM™ for max shock absorption.
- High quality elastics ensure zero budge during sparring or competition.
- Quick-Ez™ hook-and-loop closure for adjustability and easy on/off application.
- **Size:** Unisex one size.





FEATURES:-

- The use of zero impact double layered G-Core technology in combination with Maya hide leather made these protectors resilient, durable and tough.
- Molded light weight foam padding designed boot is aligned with the feet efficiently for maximum impact distribution.
- EVA-LUTION FOAM™ fortifies the instep sparring shoes against shock impact with added softness.
- High quality elastics and toe compartment for comfort and zero budge.
- Quick-Ez™ hook-and-loop ensures ease of usage with on/off application.
- Small & Medium Sizes are recommended for 10-14 years old.



SC-3BM

FEATURES:-

- Made from patented Maya Hide leather for long lasting durability Unique moulded design distributes shock throughout instep for total foot protection.
- EVA-LUTION FOAM fortifies the instep against shock impact.
- High quality elastics and toe compartment is made for comfort and zero slip experience.
- Quick-Ez hook-and-loop a secure on/off application ensures ease of usage and comfort modulation.



Sizes

Small / Large / Medium / X-Large .



SC-Z2B



PFG-PRO2U

FEATURES:-

- Authentic top grain cowhide leather build will last you and your athlete a career.
- Thick compressed and layered EVA-LUTION foam padding offers a barrage of shock-absorbency.
- Perforated for heat escape and hand comfort during those intense drills.
- Curved with an inner cowhide hand compartment for zero-slip grip while training combos.
- Handstitched and sleekly crafted for speed drills that'll increase your athletes quickness and hand-eye coordination.



PBM-PRO3U

FEATURES:-

- Full grain authentic cowhide leather.
- A unique air-pocket center with rounded design translates to super-cushioned shock-absorbency and ease of speed combos.
- Interior is further reinforced using foam padding for shock-consolidation.
- Open hand half finger design for ease of use.





PRM-1W



FEATURES:-

- Pro-style design ideal for endurance training.
- Durable Maya Hide leather construction.
- Lightweight, with maximum absorption.
- Ideal for boxing, kickboxing, martial arts, and cardio classes.



PRM-3W



FEATURES:-

- Tri-Slab, Supremo-Shock Foam and EVA-LUTION FOAM padding with Shell-Shock gel integration.
- Exclusive Ez-Grip Technology with Quick-Ez hook and loop strap for snug fit.
- 100% authentic cowhide leather makes for a highly durable and resilient pair of boxing pads.
- CoolX mesh technology wicks moisture to keep hands as cool and dry as possible.
- Domed ergonomic palm design allows for a solid grip and equal shock-dispersion.



PRM-1R



FEATURES:-

- Light, highly efficient shock absorption from EVA-LUTION FOAM and Supremo-Shock Foam.
- Exclusive Ez-Grip Technology creates traction within the pad for a better grip.
- Durable Maya Hide construction with inner Maya Hide hand compartment enhances durability of boxing pads.
- CoolX mesh technology wicks moisture to keep hands as cool and dry as possible.
- Curved boxing pads are designed with trainers in mind.
- SIZE: One Size.



SP-3BM



FEATURES:-

- Reinforced double stitching makes these boxing pads highly durable and long-lasting.
- Re-design of the outer covering for extra stability.
- Superior shock absorption provided by EVA-LUTION FOAM Technology.
- Open finger design allows for better grip and additional support.
- Efficient S.P.P ventilation system in the upper layer keeps hands free from moisture.



SPM-1R



FEATURES:-

- The Micro boxing pads are compact, measuring only 17cm in length and 5cm thick
- Hand sized focus mitts designed to improve accuracy
- Inner hand binding has reinforced stitching
- Outer covering designed for extra stability
- Comes in Pair, Maya Hide Leather made



FPM-9G



FEATURES:-

- Full grain authentic cowhide leather.
- A unique air-pocket center with rounded design translates to super-cushioned shock-absorbency and ease of speed combos.
- Interior is further reinforced using foam padding for shock-consolidation.
- Open hand half finger design for ease of use.



PB-X3R



FEATURES:-

- 3ft filled leather pro punch bag is for those looking to train with the very best equipment.
- Authentic cowhide leather offers the most durability ever experienced in a heavy bag.
- Patent Pending Double-stitched loops with high-grade steel halo ring easily attaches to chains and shackles.
- High-grade anti-rust coated 4-strand chain can withstand 50kgs+ without consequence.
- Tether loop facility allow floor anchor for better bag stability.
- Comes with Maya Hide boxing gloves that are built to endure heavy shock-impact.
- **Sizes:** 3 Feet 4 Feet 5 Feet 6 Feet





FEATURES:-

- Genuine Cowhide Leather Filled punch bag. Punchbag is 5ft.
- unique Stylish Design red and black,yellow and black.
- Highly durable construction for career-long use, using quality cowhide leather and super strong stitching.
- All-in-one kit, suitable for kickboxing, muay thai, MMA and more.
- **Sizes:** 3 Feet 4 Feet 5 Feet 6 Feet

SPM-1R



FEATURES:-

- Genuine Cowhide Leather Filled punch bag. Punchbag is 5ft.
- unique Stylish Design red and black,yellow and black.
- Highly durable construction for career-long use, using quality cowhide leather and super strong stitching.
- All-in-one kit, suitable for kickboxing, muay thai, MMA and more.
- **Sizes:** 3 Feet 4 Feet 5 Feet 6 Feet

PB-1XR



FEATURES:-

- Genuine Cowhide Leather Filled punch bag. Punchbag is 5ft.
- unique Stylish Design red and black,yellow and black.
- Highly durable construction for career-long use, using quality cowhide leather and super strong stitching.
- All-in-one kit, suitable for kickboxing, muay thai, MMA and more.
- **Sizes:** 3 Feet 4 Feet 5 Feet 6 Feet

PB-6XR



FEATURES:-

- Genuine Cowhide Leather Filled punch bag. Punchbag is 5ft.
- unique Stylish Design red and black,yellow and black.
- Highly durable construction for career-long use, using quality cowhide leather and super strong stitching.
- All-in-one kit, suitable for kickboxing, muay thai, MMA and more.
- **Sizes:** 3 Feet 4 Feet 5 Feet 6 Feet

PBF-9R



FEATURES:-

- twinned layer non tear Maya Hide Leather (waterproof & can be used outdoors).
- Punching bag is 2ft High (3ft with chains) with 28cm diameter.
- Filled with shredded textiles that give amazing shock absorption and comes with Hanging Chain.
- Exclusive deal: Maya Hide leather armours these junior Punching gloves for long life and unbreakable resiliency.
- Resilient Maya Hide leather construction makes these gloves stubbornly durable and long-lasting.

KP-B1B



FEATURES:-

- twinned layer non tear Maya Hide Leather (waterproof & can be used outdoors).
- Punching bag is 2ft High (3ft with chains) with 28cm diameter.
- Filled with shredded textiles that give amazing shock absorption and comes with Hanging Chain.
- Exclusive deal: Maya Hide leather armours these junior Punching gloves for long life and unbreakable resiliency.
- Resilient Maya Hide leather construction makes these gloves stubbornly durable and long-lasting.

KP-B3W



FEATURES:-

- twinned layer non tear Maya Hide Leather (waterproof & can be used outdoors).
- Punching bag is 2ft High (3ft with chains) with 28cm diameter.
- Filled with shredded textiles that give amazing shock absorption and comes with Hanging Chain.
- Exclusive deal: Maya Hide leather armours these junior Punching gloves for long life and unbreakable resiliency.
- Resilient Maya Hide leather construction makes these gloves stubbornly durable and long-lasting.

KP-F12



FEATURES:-

- twinned layer non tear Maya Hide Leather (waterproof & can be used outdoors).
- Punching bag is 2ft High (3ft with chains) with 28cm diameter.
- Filled with shredded textiles that give amazing shock absorption and comes with Hanging Chain.
- Exclusive deal: Maya Hide leather armours these junior Punching gloves for long life and unbreakable resiliency.
- Resilient Maya Hide leather construction makes these gloves stubbornly durable and long-lasting.

KP-P7U



FEATURES:-

- Hand Made Zero Impact G-Core 3 in1 Punch bag.
- 16 kg weight.
- Comes with Bag Gloves, Steal Chain & Floor Straps.
- Dense shock absorbing Max-Shock foam embedded.
- Durable stitching and material.
- **SIZES** : One Size.

RB-B1X



FEATURES:-

- Handmade Zero Impact G-Core Maize shaped Patent Pending Bag with 38cm diameter and 52cm Length.
- Include 4 Strand HG-Steel™ made swivel Chain Set and Maya Hide™ Leather gloves.
- Leather-X™ based Max-Shock™ foam jacket with improved shock-absorption.
- Incorporate heavy Zippex™ top closure to allow bag to fill till its maximum level Improved stitching for durability and comes with heavy-gauge D rings.
- **SIZES** : One Size.

RB-3X



FEATURES:-

- Handmade Non tear wecking ball bag for specialized training.
- Available in dimensions of 60cm round & 60 cm Length with chains.
- Set include Maya Hide Leather Gel gloves and 4 strand swivel chain set.
- **SIZES** : One Size.

RB-B2X



FEATURES:-

- super dense shock absorbing 2" inner Polyethylene foam jacket to absorb the punches and help protect your hands (18" diameter) (59" Length including chains) 6 panel design body bag.
- Comes with 6 Strand swivel Chain Set & Maya Hide Leather Gel gloves.
- Dense shock absorbing 2" inner Polyethylene foam jacket & Filled with mixture of shredded fiber.
- Heavy duty zip-fastened top closure ensures maximum fill potential (can be used outside).
- Tethered loop facility at the base of the punch bag ensures swing reduction.
- **SIZES** : One Size.

RB-B4X



FEATURES:-

- Zero Impact G-Core Handmade Angle shaped Bag with 18?" diameter and 59" Length.
- Set include Maya Hide™ Leather gloves and 6 Strand HG-Steel™ swivel Chain Set.
- Leather-X™ made Max-Shock™ foam jacket with shredded textile filled.
- Heavy-duty Zippex™ fastened closure on top to fill bag to its maximum capacity.
- TLF architecture™ at the base of the bag for swing reduction.
- Sizes: One Size.

RB-B5X



FEATURES:-

- Syntek leather punching dummy with non-tear lining to resist serious impact.
- Anatomically designed for enhanced training and contact practice.
- Made to be waterproof with a durable Nylostrap™ for secure hold.
- Comes with matching Katana bag gloves that are both resilient and comfortable.
- Measuring 3ft in height and weighing 60lbs.
- Sizes: One Size.

RB-B6X



FEATURES:-

- Standing at 5.6 ft tall this punch dummy/bob is just what you need to replicate the human body practically.
- Polyethylene base can easily be filled with sand or water for a stable base that won't tip.
- High-strength patented Maya Hide Leather is handcrafted to protect the shock-absorbent interior.
- Inner cavity is filled with urethane foam for efficient impact absorption
- Weight distribution of base provides stability and functionality.
- Sizes: 4 feet and 5 feet.

PB-T1R



KT-1X

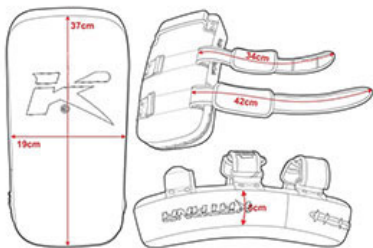

FEATURES:-

- 37cm long and 19cm wide Heavy duty strong Maya Hide Leather construction.
- 'IMT' three layers of Gel integrated thick Foam padding for heavy duty shock absorption.
- Triple re-enforced stitched and riveted leather handle. Double layered webbing re-enforced buckle straps.
- It's bidding for one pad only two pads shown in image to show reverse side of pad.
- Colors : Black & Blue, Black & White, Black & Red.



KT-2X

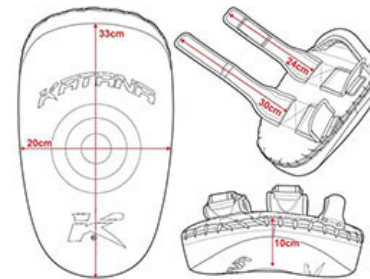

FEATURES:-

- From our DE-VOLCAN™ Ultra Edition range of elite boxing pads for amateurs or professionals.
- Made with Maya Hide™ leather for a durable strike pad that won't let you down.
- Shell Shock™ gel Equilibrium Sheet combined with Supremo-Shock Foam™ for doubled-down shock absorption and cushioning.
- Curved pad architecture with oval-shaped design to mimic the shape of your arm.
- Quick-EZ™ Hook-and-Loop strap for added shield security and adjustable comfort.



KT-3X

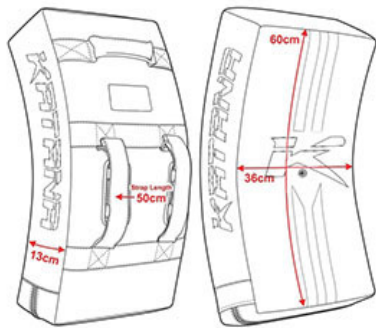

FEATURES:-

- Maya hide Leather to withstand the toughest assaults, Air vents on both sides.
- 60cm long, 36cm wide and 13cm thick 'IMT' Gel Padding, Extremely lightweight.
- Nylon reinforced 3 suitcase handle bars with additional nylon strap holds for arm.
- incorporated the latest technology in strike Shield Sold individually.
- **Sizes:** One Size.

KT-4X



FEATURES:-

- Resilient kick shield design exclusive to measuring 52cm long, 44cm wide and 13cm thick.
- Cut from tough Maya Hide™ leather for outstanding durability.
- S.P.P™ ventilation system to increase air flow and prevent moisture or odour build-up.
- Shell Shock GEL™ with integrated padding for the ultimate shock absorption.
- Curved anatomic shape with grip bars for added stability when training.
- **Sizes:** One Size.



DB-01W



FEATURES:-

- Latest authentic cowhide leather precision ball is hand-stitched for unmatched durability.
- Non-tear rubber bladder promises career lasting toughness Easily attached from floor to ceiling.
- The bag is hand stitched so you do not have to be concerned about tearing or cracking.
- Includes two D-Shackles which are to be attached to the floor and ceiling.
- **Sizes:** One Size.

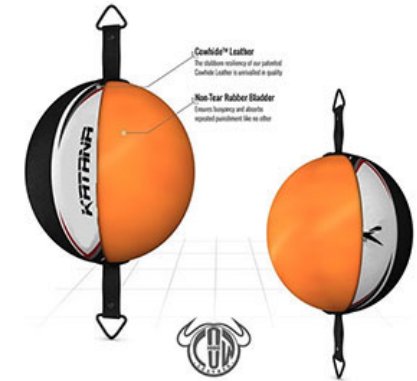

DB-3NB

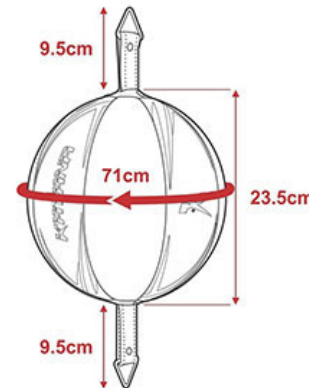

FEATURES:-

- Katana Patent Pending high quality Cow Hide leather Double End Speed Ball lined inside with 2 layers of textiles.
- Comes with Heavy-duty nylon strap & rubber bungee cord adjustable up to 48 inches.
- Includes two hooks and fixings which are attached to the floor and ceiling.
- Move around in all directions developing excellent hand to eye coordination.
- The ball is hand stitched to the highest standards and has a rubber bladder inside.
- **Sizes:** One Size.



FEATURES:-

- Authentic cowhide leather is long-lasting, durably and stubbornly resilient.
 - Double-stitched and riveted for unbreakable durability.
 - Built for optimum hand eye coordination and punch speed.
 - Available colours: Gray & Black, White & Black.
- Sizes: X-Small, Small, medium.

SB-2WB



FEATURES:-

- Authentic cowhide leather is handcrafted for solid durability and long-lasting product life.
- EVA padding on the inside of these focus sticks consolidates shock-impact without losing structural integrity or form.
- 3.8 cm foam on tips provides a soft target.
- 44 cm long with a 4 cm girth for ease and comfort of use.
- Color: Red and Dark Blue.
- Size: One Size.

CT-3B



FEATURES:-

- Authentic cowhide leather is long-lasting, durably and stubbornly resilient.
 - Double-stitched and riveted for unbreakable durability.
 - Built for optimum hand eye coordination and punch speed.
 - Available colours: White & Black, Yellow & Black.
- Sizes: X-Small, Small, medium.

PB-4YW



FEATURES:-

- Full grain authentic cowhide leather will last you and your athlete a career.
 - Compressed closed cell foam is layered to offer a solid shock-absorbent experience to last you countless sessions.
 - Thick handle is ergonomically designed to fit the hands efficiently.
 - High-quality solid nylon strap requires you to simply feed arm through and grab the paddles for a zero-slip training experience.
 - Handcrafted and stitched using high-quality nylon threads.
- Color: Red and Dark Blue.
Size: One Size.

CT-6B



CM-7KD

FEATURES:-

- Similar to the 3ft wall-bracket Advanced Series, KATANA ultimate foldable heavy-bag wall mount bracket is a smaller design but just as sturdy.
- Arm protrudes out 63CM away from wall, allowing for space and movement around heavy-bag.
- Reinforced constitution holds up to 70KGS while 38.5CM heavy-duty steel gauge tripod bracket gives added support, reducing metal fatigue.
- Four bolt points, 2 on top (19CM) and 2 on bottom (20.5CM), holds 61 CM beam vertically against wall.
- Wall construction should be breeze block or brick only.



CM-8KT

FEATURES:-

- Authentic KATANA ultimate 9kg heavy steel gauge 2ft wall bracket.
- Holds heavy bags up to 300 lbs. Bracket arm retracts and swings in to wall to move the bag out of the way when not in use.
- A heavy duty steel gauge Bracket incorporating stabilizing arms for minimal sideways movement and metal fatigue.
- The reinforced construction allows the heaviest bag to be held easily.
- Six bolt points hold the bracket tightly against the wall.



CM-10KC

FEATURES:-

- Uniquely built KATANA iron strength punching bag bracket to hold up to 200 lbs.
- Designed with 6 bolt points for unbeatable strength and security.
- Powder coated bracket for enhanced durability and resilience against wear and tear.
- Unique Red Oxide anti-rust formulation for all weather use.
- Foldable design which stores flush against the wall to save space in the gym.



BA-C2X

FEATURES:-

- HG-Steel™ built 4 strand chain for imperishable power.
- Powder coated hardware for a heavy bag chain that resists wear and tear.
- Strong swivel designed to handle up to 100kg and to provide smooth rotation.
- Ergonomically engineered making it ideal for smaller gym spaces.
- Comes with all necessary screws and fixings for easy installation.



BA-C3X

FEATURES:-

- HG-Steel™ built 6 strand chain for unbreakable strength.
- Powder coated metal for punch bag chains that endure all weather.
- Strong steel swivel designed to handle up to 100kg heavy bags.
- Ergonomically engineered making it ideal for smaller gym spaces.
- Comes with all necessary screws and fixings for easy installation.



BA-C6X

FEATURES:-

- KATANA Heavy Duty 45cm wide Punch Bag Anchor System.
- Maximum swing reduction without having to drill holes in the floor.
- Constructed of Non tear high-quality Maya Hide Leather.
- Fashioned with Heavy duty zip-fastened closure.
- Comes Unfilled can be filled with sand.
- Colors: Black and white, Deep yellow and white.



CM-7KD

FEATURES:-

- KATANA hook comes with swivel and made from high quality Powder coated 18 Gauge Steel which has been specially shaped and made for punch bags and treated with Special Red Oxide anti-rust formulation.
- The product has been powder coated to give it extra life and make it weather proof and suitable for all environments.
- The hook can hold up to 100 kgs, This new version of the KATANA ceiling hook now comes with heavy duty shield bolts for fixing the bracket to beam.
- SIZES: One Size.



CM-8KT

FEATURES:-

- Made with 18-gauge HG-Steel™ for a strong ceiling hook that takes up to 100kg.
- Treated with Red Oxide for anti-corrosion capabilities and suitable for outdoor use.
- Laboratory tested to the strictest standards for strength and endurance.
- Superior quality D shackle for added stability and smooth movement of the bag.
- Easy to assemble and comes complete with 4 industrial shield bolts.
- SIZES: One Size.

FEATURES:-

- Material: Stainless Steel.
- Diameter: About 12 cm/ 4.7 inch.
- Weight capacity: 300kg/ 661lb.
- Specially designed to anchor your suspension trainer either indoors or outdoors.
- With this versatile wall / ceiling mount, you can perform exercises anywhere you choose.
- SIZES: One Size.



CM-10KC



WH-8KS



WH-9KS



WH-10KS

FEATURES:-

- HG-Steel™ built 78cm tripod to hold considerable weight and withstand tough workouts.
- 13.5cm double reinforced swivel hook to support heavy bags up to 100kg.
- 90cm protruding arm allows 360 degree movement to enhance your training.
- Bracket treated with Red Oxide anti-rust formulation making it suitable for outdoor use.
- A foldable design that can be done without removing bag for complete convenience.
- SIZES: One Size. COLORS: White and Black.

FEATURES:-

- 16 gauge powder coated non-slip iron beam (46cm out of the wall) with gussets for durability.
- Heavy duty wall brackets for reinforced strength to take up to 130kg weight.
- Red Oxide coating for anti-rust benefits making it ideal for all weather use.
- Designed for multi-purpose use with pull up bar and bag attachment.
- Easy to install and comes with all necessary fixings and assembly instruction.
- SIZES: One Size. COLORS: White and Black.

FEATURES:-

- Made from high-grade iron that is long-lasting and stubbornly durable.
- Bracket arm extends 90cm away from the wall allowing 360 degree movement.
- Powder coated with H-CR™ anti-rust layering for all around weather use.
- Efficient design allows to utilize space perfectly, with or without a heavy bag.
- Can carry up to 250lbs with ease.
- SIZES: One Size. COLORS: White and Black.



CM-4DK

FEATURES:-

- The KATANA elite swivel has a reduced centre hub for speed/balance and rhythm.
- Made from a high grade of stainless steel and Silver nickel plated.
- Additional quick release pin feature for ease of removal of ball.
- Smooth rotation due to the low friction ball bearings.
- Comes with all fixings.
- **SIZES:** One Size.

FEATURES:-

- This is KATANA's new top of the line professional quality steel ball bearing training bag Swivel, made for optimum speed, precision, durability and performance. It has a two point board fixing.
- The weight of this swivel is combined with a super smooth ball bearings that allows the speedball to swivel quickly enough to test athletes.
- They are treated with a special red oxide anti-rust formula, and comes with a powder coated steel for added strength.
- The speedball swivel are silver nickel plated stainless steel crafted with sealed bearing professional mechanics and that offers lightning quick action.
- **SIZES:** One Size.

FEATURES:-

- Manufactured from high grade HG-STEELTM, KATANA ball bearing steel swivel provides stability and resistance to corrosion, to last a lifetime.
- Its ergonomic design uses professional mechanics which keeps it stable even after quick action. Red oxide primer coating protects the steel from rust and corrosion.
- Low friction ball bearings combined with low weight swivel provide smooth rotation for the attached punch bag.
- **SIZES:** One Size.



CM-7KD



CM-J3D



CM-L4K

FEATURES:-

- Manufactured from high grade HG-STEELTM, KATANA ball bearing steel swivel provides stability and resistance to corrosion, to last a lifetime.
- Its ergonomic design uses professional mechanics which keeps it stable even after quick action. Red oxide primer coating protects the steel from rust and corrosion.
- Low friction ball bearings combined with low weight swivel provide smooth rotation for the attached punch bag.
- The swivel is made more secure through master link assembly to keep the ball safe from thefts.
- **SIZES:** One Size.

FEATURES:-

- KATANA's Universal Ceiling Hook consists of two smooth rotatable and adjustable pieces that are made of Silver nickel plated Stainless steel.
- Coated with Red-Oxide powder, these universal ceiling hook.
- Lightweight, sturdy and highly durable, hang just about anything ranging between 20 – 120 KGS, from speed-balls to heavy-bags on our new and improved hooks with dimensions spanning 13.5 CM x 9 CM.
- **SIZES:** One Size.



CM-1KO

FEATURES:-

- KATANA's Universal Ceiling Hook consists of two smooth rotatable and adjustable pieces that are made of Silver nickel plated Stainless steel.
- Coated with Red-Oxide powder, these universal ceiling hook.
- Lightweight, sturdy and highly durable, hang just about anything ranging between 20 – 120 KGS, from speed-balls to heavy-bags on our new and improved hooks with dimensions spanning 13.5 CM x 9 CM.
- **SIZES:** One Size.



CM-S2H



EC-1R

FEATURES:-

- Made using Sineo™ material for strength and resilience.
 - Incorporate AeroTherm™ moisture-wicking technology to keep skin dry.
 - Improved strength with T5 stitching™ for enhanced resilience.
 - Incorporate NEO-II™ material to ensure compression, heat retention and blood flow.
 - Ergonomically designed for contour fit and conformity to the knee for quick healing.
- (THIS IS SOLD AS SINGLE ITEM)



EC-8B

FEATURES:-

- Combination of SBR, Polyester, Rubber, and Nylon materials for super durability.
 - Dual straps for tight hold. One size fits all.
 - Ergonomic design to fit perfect on the elbow joint area.
 - High quality stitching for long-lasting performance.
 - Moisture and heat control technology.
- (THIS IS SOLD AS SINGLE ITEM)

SIZE CHART

SIZE	ELBOW CIRCUMFERENCE
S/M	20cm-25cm
L/XL	26cm-30cm
2XL	31cm>

(S/M SIZES AGE RECOMMENDED FOR UP To 14 YEAR OF AGE)



WS-9B

FEATURES:-

- Wraparound design provide Level I protection for Tendinitis, arthritis, bursitis and sprains.
 - Made using NEO-II™ material for compression and therapeutic heat retention to relieve pain.
 - Incorporate Quick-Ez™ hook & loop closure for perfect fitting.
 - Thumb hole to avoid shifting and ensure free thumb moment.
 - Unique T5 stitching™ for improved strength.
- (THIS IS SOLD AS SINGLE ITEM)



WS-5W

FEATURES:-

- Features Sineo™ fabric construction for increased wrist protection.
 - Unique R-CL™ technology to wick away moisture and keep the inner skin dry.
 - AeroTherm™ technology to remove excess perspiration and ensure breathability.
 - Comes with elite-quality Shell-Shock™ Gel padding for better wrist support.
 - Comes with a thumb-hole to ensure stability and allow free functionality of the hand.
- (THIS IS SOLD AS SINGLE ITEM)

SIZE CHART

AVAILABLE SIZES S/M, L/XL.
(S/M SIZES AGE RECOMMENDED FOR UP To 14 YEAR OF AGE)



EC-7B

FEATURES:-

- Made with exclusive Sineo™ material to ensure durability.
- Incorporate special AeroTherm™ moisture-resistant technology for dry skin.
- Special T5 stitching™ for improved durability and support.
- Provide compression and heat retention through the use of NEO-II™ material.
- Anatomic Skin-X™ design for safety of tendons and ligaments. (THIS IS SOLD AS SINGLE ITEM)



FEATURES:-

- Exclusive neoprene and SBR blend ensures durability and is abrasion resistant.
- Fabric wicks moisture absorbing sweat for comfortable and dry feeling.
- Special T5 stitching makes the product threshold for stretching much more efficient.
- Silicon printing provides traction for zero-slip grip experience. Nylon mesh behind the elbow helps trap cool air to replace warm air. (THIS IS SOLD AS SINGLE ITEM)

EC-4G



EC-6G

FEATURES:-

- Exclusive neoprene and SBR blend ensures durability and is abrasion resistant.
- Fabric wicks moisture absorbing sweat for comfortable and dry feeling.
- Special T5 stitching makes the product threshold for stretching much more efficient.
- Silicon printing provides traction for zero-slip grip experience. Nylon mesh behind the elbow helps trap cool air to replace warm air. (THIS IS SOLD AS SINGLE ITEM)

SIZE CHART

SIZE	ELBOW CIRCUMFERENCE
S/M	20cm-25cm
L/XL	26cm-30cm
2XL	31cm>

(S/M SIZES AGE RECOMMENDED FOR UP To 14 YEAR OF AGE)



EC-5W

FEATURES:-

- KATANA Neoprene knee Gray/Black fits well to the Knee and supports it with the anatomical design to avoid the possible injuries to the knee and provide comfort during the sport.
- The high-quality RDX Neoprene Knee is manufactured using the durable material that speaks of its quality via its utility and long life. (THIS IS SOLD AS SINGLE ITEM)

SIZE CHART

SIZE	ELBOW CIRCUMFERENCE
S/M	34cm-39cm
L/XL	40cm-45cm
XXL	46cm-52cm

(S/M SIZES AGE RECOMMENDED FOR UP To 14 YEAR OF AGE)



CM-7KD



BA-C2X



FEATURES:-

- Simple triple strap hook-and-loop closure system.
- Unique blend of SBR, Nylon, Polyester, and rubber.
- Anti-moisture and anti-microbial features imbued in the fabric.
- Heat retention properties for increased comfort.
- Designed for ankle sprains, foot and ankle tendinitis, and other ankle issues.
- **Size:** One Size.
(THIS IS SOLD AS SINGLE ITEM)

FEATURES:-

- New unique Silicon/ Neoprene design offer firm and steady assistance from plantar fasciitis discomfort.
- Design to follow contours of ligaments and tendons, to provide additional provision and firmness to the ankle.
- Heat Retention technology for increased blood flow and oxygen supply, it removes excess perspiration and allows the skin to breathe.
- Extra compression and support for quick healing of injuries.
- It helps to soothe and protect against stiff joints and muscles.
- Available Sizes: S/M. L/XL. 2XL.
(THIS IS SOLD AS SINGLE ITEM)

CM-8KT



BA-C3X



CM-10KC

FEATURES:-

- Ankle support has been designed with a non-slip sole to provide grip, support & stability.
- Unique design for better proprioception and natural stabilization.
- Neoprene/Silicon Ankle Support features new unique silicon innovation technology.
- Compression and support and to promote faster recovery from injury.
- The Silicon design follows the contours of the tendons and ligaments to Provide additional support and compression to the ankle.
Available Sizes: S.M.L
S&M sizes are recommended for 14 years of age
(THIS IS SOLD AS SINGLE ITEM)

FEATURES:-

- Exclusive technology for Neoprene/Silicon Ankle support.
- Design to follow contours of ligaments and tendons.
- Heat Retention technology for increased blood flow and oxygen supply.
- Extra compression and support for quick healing.
- Breathable construction.
- Anti-moisture technology.
- **Size:** One Size.
(THIS IS SOLD AS SINGLE ITEM)

FEATURES:-

- Made using exclusive NEO-II™ material for perfect stability and durability.
- MMT™ technology removes perspiration while ensuring breathability.
- Designed for contour fit and treated with AM-S™ for anti-microbial properties.
- Short Toe opening to get rid of any risk of slipping.
- Elegantly design with beautiful texture for impressive look.
- Sold as single item.
- **Size Guide:**
Small/Medium size recommended for 10 to 14 years old.
Large/X-Large size recommended for over 14 years old.
(THIS IS SOLD AS SINGLE ITEM)



WE-4B

FEATURES:-

- KATANA oil-tanned Nubuck leather offers unfaltering back support during exercise and fitness workouts! Enhance your lifting technique and protect your posture.
- this belt will support the abdominals and the back to get the most out of each rep.
- HG-steel buckle is rust proof and allows easy adjustability.
- Available colors: Black,Brown.

Size Chart	M	L	XL
WAIST	30"-35"	35"-40"	40"-45"



WE-5B

FEATURES:-

- KATANA dipping belt is made for improved lower-back performance and comes with a unique P-PL™ webbing.
 - The outer layer of the belt is made with Nylofab™ layer for improved resistance.
 - The chain, speed clip and D shackle is made of exclusive HG-Steel™ for strength.
- Available Sizes: One Size.



WE-1BG

FEATURES:-

- KATANA 6 inches wide solar Power weight lifting belt is contoured to the shape of the human body.
- This unique design offers the sought after firm support of conventional rigid-style belts, but with a comfort load approaching out elastic-style belts.
- This design also reduces the problem of the belt riding up on the body.
- Rugged, wide webbing helps tighten the belt in the key areas over the abdomen and at the lumbar area.
- Available colors: Black and Grey , Black and Mint Green.

Size Chart	S	M	L	XL
WAIST	26"-30"	30"-34"	34"-38"	38"-42"



WE-9B

FEATURES:-

- The RDF weight lifting belt is available in 4.5-inch width for abdominal coverage and support.
- Special SSR technology enables improved spine support during intense training.
- The belt is made of exclusive cordless material and includes RuGrip straps in the center of the belt for compactness.
- High fastening system with HG steel buckle for comfort and abdominal support Made with a unique wireless material and a wide range of endurance Special RuGrip belts in the center on the compact belt.

Size Chart	S	M	L	XL
WAIST	27"-33"	31"-37"	35"-41"	39"-45"



WE-3X

FEATURES:-

- Highest quality NAPPA calf-leather that is soft and durable.
- Industrial grade, rust proof, steel buckle with roller that can last years.
- Embossed KATANA logo on the inside for a premium look.
- Strengthened stitching to support sturdiness of the belt.
- Quality rivets for improved weightlifting belt performance.



WE-8D

FEATURES:-

- Oil tanned Nubuck leather for a weight lifting belt that feels soft and gel-like to touch.
- Highly durable construction to withstand the toughest of workouts.
- Shock absorbent leather to reduce stress or fatigue when you're lifting.
- Contoured design to hug the natural curves of your body for maximum comfort.
- Reinforced stitching with heavy duty rivets and buckle for strength and performance.



WE-2B

FEATURES:-

- Extra padding on the inside for better spine support and comfort.
- Additional layer of buffalo leather for superior durability.
- NAPPA leather for soft feel.
- High quality steel buckle and rivets.
- Unique embroidery and two color leather weightlifting belt

SIZE CHART

SIZE CHART	WAIST SIZES
SMALL	24" - 29"
MEDIUM	29" - 34"
LARGE	34" - 39"
X-LARGE	39" - 44"
2X-LARGE	44" - 50"



WE-6B

FEATURES:-

- The 6 Inch wide KATANA stitched logo Top Quality Cowhide Leather Carbon fiber Padded Belt provides you support and reduces the stress placed on your back when weight lifting.
- Soft suede lining. Built-in Carbon fiber lumbar pad.
- Double-prong seamless roller buckle. Double-stitched edges.
- Double loops to secure belt tab. Once you try on one of these belts you cannot go back to another belt.

SIZE CHART

SIZE CHART	WAIST SIZES
SMALL	24" - 28"
MEDIUM	28" - 32"
LARGE	32" - 36"
X-LARGE	36" - 40"
2X-LARGE	40" - 45"



WE-4GB

FEATURES:-

- KATANA revolutionary anatomically shaped anchor system belt with two built in flexible steel spinal cord springs and 6 Carbon fiber stays improves your posture and restricts movement to aid treatment of back problems.
- Uniquely designed with closed cell neoprene rubber with overlapping abdominal double-pull tension straps designed to prevent and rehabilitate tissue injuries, variable compression support system and retains heat.
- Available Sizes: Small,Medium,Large,XLarge.



WE-B3

FEATURES:-

- Made from high performance neoprene for durability and resilience.
- Exclusive three layer padding for multidirectional cushioning and protection.
- Lined with a super soft polyester shearing for unbeatable comfort.
- 28 inch chromed HG-Steel™ constructed chains and D shackles for unbreakable power.
- Quick-Ez™ hook & loop fastening for complete adjustability for all head size.



WS-6BR

FEATURES:-

- KATANA Training Weight Lifting Gym Straps inhibit the calluses, cuts, and relevant injuries during the gym workouts and provide hand safety.
- The Elite-Quality KATANA gym straps are manufactured with the stretchable and durable material and are tested painstakingly for performance.
- Available Sizes: One Size.



WS-2P

FEATURES:-

- KATANA Ladies Weight Lifting Gym Strap is designed specifically for women athletes by KATANA.
- Its built is perfected utilizing the same resources used for the gym strap for men with the difference of the designing and ratio.
- The women specific KATANA Gym Strap is made for high level comfort and durability for lasting appeal and use.
- Available Sizes: One Size

FEATURES:-

- Authentic KATANA Pair of Advanced Weight Lifting Pro Series Straps.
- Heavy duty 3" wide and 18" to 19" extended length, One size fit all.
- Constructed from a heavy blend cotton-eglantine for maximum support.
- Thumb loops with extra length hook and loop to ensure they never shift.
- You'll be amazed at the extra weights attained, Sold as Pair.
- SIZES: One Size.

WE-L8B
FEATURES:-

- Train with enduring sports brand KATANA Wrist Wraps are a combination of the best in comfort and durability perfectly suited for heavy lift days.
- These heavy duty 3" wide and 19" extended length wraps are made from cotton elastic for maximum support and thumb loops with extra length to ensure they never shift when in use.
- Constructed from a heavy blend cotton-eglantine for maximum support and longevity.
- Our wrist straps provide the ultimate in support and protection for the wrists so you can blast your way past your current boundaries you'll be amazed at the extra weights attained.
- One size fit all. Sold as Pair.

WE-L9

FEATURES:-

- Gym Straps are made from highly-durable Neoprene material for long-life and added comfort Interior is padded to reduce pressure and absorb shock maintaining solid grip on wrists without budging or slipping Ergonomic wrist strap design allows for perfect grip, enabling better lifting posture and technique to make most out of each rep Quick-EZ closure enables convenient on/off strapping with adjustability options HG-Rust treated heavy-duty hook and loop fights rust and enables easy hassle-free application.
- SIZES: One Size.

WS-L2B

FEATURES:-

- Made from highly-durable Neoprene material for long-life and added comfort.
- Interior is padded to reduce pressure and absorb shock while maintaining solid grip.
- HG-Rust treated Heavy-duty hook and loop fights rust and enables easy hassle-free strapping.
- Quick-EZ hook and loop closure enables convenient on/off strapping with adjustability options for desired comfort.
- Ergonomic palm strap design allows for perfect grip to make the most out of each lift feel of weights to allow the most comfort an intense session can afford.
- SIZES: One Size.

WS-L4P



FEATURES:-

- Made from highly-durable Neoprene material for long-life and added comfort.
- Interior is padded to reduce pressure and absorb shock & maintaining solid grip on wrists without budging or slipping.
- Ergonomic palm strap design allows for perfect grip, enabling better lifting posture and technique to make most out of each rep.
- Quick-EZ hook and loop closure enables convenient on/off strapping with adjustability options.
- HG-Rust treated heavy-duty hook and loop fights rust and enables easy hassle-free application.
- SIZES: One Size.

WE-2BR



FEATURES:-

- Made from highly-durable Neoprene material for long-life and added comfort.
- Interior is padded to reduce pressure and absorb shock & maintaining solid grip on wrists without budging or slipping.
- Ergonomic palm strap design allows for perfect grip, enabling better lifting posture and technique to make most out of each rep.
- Quick-EZ hook and loop closure enables convenient on/off strapping with adjustability options.
- HG-Rust treated heavy-duty hook and loop fights rust and enables easy hassle-free application.
- SIZES: One Size.

WE-1BG



FEATURES:-

- Supplied as a pair and can be used in a variety of lifting scenarios and with various techniques.
- Gym grips are ergonomic and flexible, without the need for gloves, which allows for better bar feel and grip.
- Foam and rubber combo ensures perfect gripping form to allow you to concentrate on the lift.
- Protects the skin from damage without sacrificing feel, allowing you to train longer and harder.
- SIZES: One Size.

WS-4WB



FEATURES:-

- Scientifically Developed Reverse Grip.
- The hook is set "in" towards the palm of your hand.
- Attachable to dumbbells or weight lifting.
- Customizable Quick-Ez hook & loop closure.
- "No-Slip" Custom Engineered Material.
- SIZES: One Size.

WS-5WB



FEATURES:-

- Shock-absorbent padding for improved stability.
- Adjustable Quick Ez hook & loop ankle and thigh use.
- 12 "long & 4" width.

WA-1B



FEATURES:-

- Maya Hide™ leather for durable straps that will support your weight and resist wear and tear.
- Soft cushioning that offers both sweat resistance and rip resistance.
- Extra wide straps with thick padding to provide your arms with cushioning and comfort.
- Long handles to give you advanced grip for every workout.
- Heavy duty oversized D-ring clips made of steel for unbreakable power.

WA-4BG



FEATURES:-

- Maya Hide™ leather for durable straps that will support your weight and resist wear and tear.
- Soft cushioning that offers both sweat resistance and rip resistance.
- Extra wide straps with thick padding to provide your arms with cushioning and comfort.
- Long handles to give you advanced grip for every workout.
- Heavy duty oversized D-ring clips made of steel for unbreakable power.

WA-5BL



FEATURES:-

- Heavy lifting was never been so easy.
- These KATANA hand bar straps made by super resilient Nylon lined with shock absorbent neoprene padding for extra comfort.
- Athletes especially from strongman competition, powerlifting, weightlifting, bodybuilding and crossfit can experience even heavier lifts.
- Ideal for deadlifts, single arm rows, pull ups and a lot more exercises in gym or even outdoors.
- Extremely wrist supportive during heavier sessions.
- One size fits all. Sold in pairs.

WA-7BR



FEATURES:-

- Uniquely contoured rigid metal design allows you to isolate your arms and shoulders.
- Webbed nylon belt, a thick, oversized neoprene neck pad, and dense elbow pads.
- The strap features a quick release to adjust it to the perfect position.
- Bulk up your biceps each time you grab a workout bar with the KATANA Bicep Bomber.
- One size fits all

WA-3WB



FEATURES:-

- Authentic KATANA Commercial Grade High density integrated Barbell.
- Fits all standard bars extra long 16" pad length.
- Features an easy-on easy-off full length hook and loop closure.
- Designed for function fit and comfor.

WA-8BR



FEATURES:-

- 15" high-quality rope.
- Easy hook up with large carabiner.
- Thick rope with rubber ends.
- Tricep Rope to perform variety of exercises.
- Attachment clip for enhanced compatibility with cable machines.

WA-2BG



FEATURES:-

- 15" high-quality rope.
- Easy hook up with large carabiner.
- Thick rope with rubber ends.
- Tricep Rope to perform variety of exercises.
- Attachment clip for enhanced compatibility with cable machines.

WA-3BG

TE-4WB



FEATURES:-

- Exclusive KATANA bomb-proof construction chin up bar to take up to 150kg in weight.
- Grip Flex™ padding for improved comfort and a solid grip for the user.
- Universal bar diameter of 3.175cm perfect for all hand sizes.
- Anti-corrosion treatment for all weather use and to prevent rust.
- Electroplated high grade steel for incredible durability and resistance against wear.

FEATURES:-

- Made from high grade HG-Steel™ for unbreakable strength and lasting performance.
- Heavy duty brackets that can take up to 130kg in weight and can be used in all weather.
- Anti-rust treatment with electroplating for indoor and outdoor use.
- Anti-corrosion formulation and textured white powder coating to resist wear and tear.
- Measures 113cm wide and extends 40cm from the wall to provide plenty of room.

TE-4W



TE-3WB



FEATURES:-

- Constructed from high grade HG-Steel™ for unbreakable strength.
- Red Oxide treated steel to prevent corrosion and rust.
- Maya Hide™ leather arm pads for a dip bar station that will last and last.
- Supremo-Shock Foam™ for the ultimate shock resistance and cushioning.
- Multiple grip positions for safe and versatile dipping bars.



FB-2BG

FEATURES:-

- Perfect alternative of medicine ball, Dumbbells or Barbells.
- Recommended for both outdoor and indoor use.
- Ideal gear for muscles building, fat burns and utmost agility.
- Zipper enclosure for instant weight adjustment.
- Featured with both top and side handles for extra utility.
- Size: one Size.

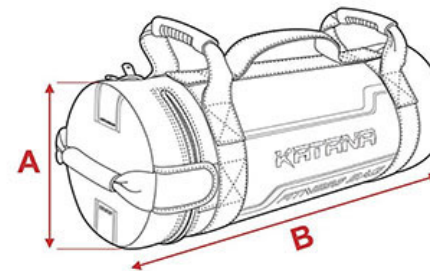

SIZE CHART

WEIGHT	A	B
5 KG	22cm	55cm
10 KG	22cm	58cm
15 KG	23cm	63cm
20 KG	23cm	67cm
25 KG	25cm	71cm



JR-6BM

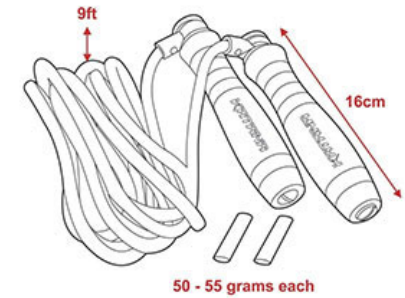

JR-5B



FEATURES:-

- Adjustable 3000mm PVC coated steel wire is super-durable, light and unaffected by weather conditions.
- Handles are made from light but stubbornly solid aluminum and are slightly thicker and heavier than average ropes for comfy grip and weightage.
- Comes with special Alan Key tool for convenient rope adjustment to fit your size.
- Special swivel design ensures a tangle and drag free experience with up to double or triple revolutions per hop.
- Patent Pending Skipping Rope Comes with special bag for easy storage and mobility.
- Colors: **Blue**, **Black**, **Golden**, **Silver**, **Pink**.
- Size: Standard.

FEATURES:-

- 9 ft 100% leather rope that can be cut down to any size.
- Comes with 90 degree perpendicular swivel design.
- comfort-grip wooden handles are designed for an ergonomic grip.
- dynamic swivel design that can keep up with your toughest.
- Adjustable weights in the handles for efficient training performance.
- color: beige.
- Size: One Size.

JJ-4SM
FEATURES:-

- This is a comfortable and durable BJJ Jiu Jitsu Gi Kimono.
- Constructed with 100% cotton preshrunk, Single weave one-piece jacket.
- Has a large cover reinforcement on shoulder, lapel, grappling chest and sleeves.
- Katana Jiu Jitsu cut is tighter and shorter than regular Judo Gi's in sleeves and waist but still provides great freedom of movement.
- Pants constructed with 100% preshrunk 10oz twill cotton for durability and comfort.
- Drawstring waist for adjust and secure fit easily.



Size Chart BJJ Jiu Jitsu						
Uniform Size	#K0	#K1	#K2	#K3	#A0	#A1
Height	3.2" - 3'5"	3'5" - 3'10"	3'10" - 4'3"	4'3" - 4'8"	4'8" - 5'1"	5'1" - 5'6"
Weight	30 - 40 lbs.	40 - 55 lbs.	55 - 70 lbs.	70 - 90 lbs.	90 - 110 lbs.	110 - 140 lbs.

Uniform Size	#A2	#A3	#A4	#A5	#A6
Height	5'6" - 5'11"	5'11" - 6'2"	6'2" - 6'5"	6'5" - 6'8"	6'8" - 6'11"
Weight	140 - 170 lbs.	170 - 200 lbs.	200 - 230 lbs.	230 - 260 lbs.	260 - 290 lbs.

MJ-2BM
FEATURES:-

- 100% cotton made. Easy to wash and is durable.
- 4.5cm wide for just the right amount of width to fit comfortably in the hands.
- 0.5 cm thick and resilient. Will not lose shape.
- Handles sweat and absorbs it efficiently.
- Comes in sizes: A1-A2-A3-A4-A5.
- Colors: [Blue](#), [Grey](#), [Black](#), [Purple](#)

SIZE CHART FOR BJJ BELT

SIZE	LENGTH (In)	LENGTH (cm)
A1	105	265
A2	110	280
A3	117	297
A4	122	310
A5	131	332



FEATURES:-

- The KATANA MMA Shorts have strong Grip Waistband for an Accurate Fit.
- Ergonomically-designed with athletic cuts for free mobility.
- Quality fabric that resists splits, tears and cracks.
- Exclusive T3 stitching for higher strength and improved resilience.
- Made with supreme durability, functionality and complete breathability.
- Sizes: One Size.

MS-6FM



FEATURES:-

- Constructed from polyester and stretchable fabric, Professional quality and ultra successful shorts.
- Multiple flex panels for excellent mobility, Panel in thigh, helps keeping opponent from escaping.
- Split seam for superior flexibility, Innovative tie system with improved Velcro closure.
- T3 stitching seams withstand the most extreme amount force.
- Internal pocket in side the shorts, which is ideal for gum shield.
- Sizes: One Size.

MS-7FM

SHORT SIZE	WAIST SIZE
X - SMALL	28" - 29"
SMALL	30" - 31"
MEDIUM	32" - 33"
LARGE	34" - 35"
X - LARGE	36" - 37"
2X - LARGE	38" - 39"



MT-8BW

FEATURES:-

- This is a comfortable and durable BJJ Jiu Jitsu Gi Kimono.
- Constructed with 100% cotton preshrunk, Single weave one-piece jacket.
- Has a large cover reinforcement on shoulder, lapel, grappling chest and sleeves.
- Katana Jiu Jitsu cut is tighter and shorter than regular Judo Gi's in sleeves and waist but still provides great freedom of movement.
- Pants constructed with 100% preshrunk 10oz twill cotton for durability and comfort.
- Drawstring waist for adjust and secure fit easily.



KATANA COMPRESSION PANTS
SIZE CHART IN INCHES

PANTS SIZE	S	M	L	XL	XXL
⊖ WAIST	27"-29"	30"-32"	33"-35"	36"-38"	39"-42"
⊕ LENGTH	33.5"	34.5"	35"	36"	36.5"



MS-7FM



MS-9BW

FEATURES:-

- KATANA flex 4-way stretch Thermal Compression Shorts & next generation Groin Guard.
- Anti-microbial fabric that wicks moisture & Maintain body temperature.
- Groin Guard engineered from advanced materials High-impact polycarbonate.
- Reduce muscle movement and vibration and focus the direction of the muscle.
- Gel polymer absorbs the impact shock instead of transferring it to the body.

SHORT SIZE	S	M	L	XL	2XL
⊕ WAIST	26"-30"	28"-34"	32"-38"	34"-40"	36"-42"
⊖ LENGTH	17"	18"	19"	20"	21"



FEATURES:-

- KATANA flex 4-way stretch Thermal Compression Shorts & next generation Groin Guard.
- Anti-microbial fabric that wicks moisture & Maintain body temperature.
- Groin Guard engineered from advanced materials High-impact polycarbonate.
- Reduce muscle movement and vibration and focus the direction of the muscle.
- Gel polymer absorbs the impact shock instead of transferring it to the body.

KATANA		COMPRESSION SHORTS SIZE CHART IN INCHES				
SHORT SIZE	S	M	L	XL	2XL	
⊕ WAIST	26"-30"	28"-34"	32"-38"	34"-40"	36"-42"	
⊖ LENGTH	17"	18"	19"	20"	21"	

*There might be tolerance of 0.5" in every measurement.



MS-4BG

FEATURES:-

- MS-Warms the waist helping you shed excess water weight.
- Improve circulation, facilitates metabolism of the abdominal.
- Flat-lock seams & an anatomical cut give total freedom of movement.
- Application of these shorts will reliably protect body from overcooling.
- KATANA Flex DS 1.9mm thermal neoprene shorts designed to provide soft tissue support.
- Groin Cup Not Included7FM.

SHORT SIZE	S	M	L	XL	XXL
⊕ WAIST	28"-30"	30"-32"	32"-34"	34"-36"	36"-40"
⊖ LENGTH	20"	21"	22"	23"	24"



CS-8BG

FEATURES:-

- High performing NEO-II™ neoprene fabric for a durable and comfortable base layer top.
- Anti-rash properties to protect your skin and prevent from discomfort during training.
- High-neck for extra coverage and anatomically designed to conform to your body perfectly.
- Heat retention to keep the inner skin warm and improve blood circulation.
- Reinforced stitching to improve strength and ensure mobility.

SIZE	Weight	Chest
Medium	140 - 170 lbs	34" - 38"
Large	170 - 200 lbs	38" - 42"
X-Large	200 - 230 lbs	42" - 46"
XX-Large	230 - 260 lbs	46" - 50"



CS-7BM

FEATURES:-

- Ultra Flex 3mm neoprene fabric for a gym sauna suit that assists in keeping trim.
- Heat trapping system increases sweat output, maintains muscle temperature and increases circulation.
- Ergonomically designed to offer freedom of movement during workouts or high intensity training.
- Front zip closure for ease of use and added security.
- Easy hand wash item and dries quickly after washing.

SIZE	Weight	Chest
Medium	140 - 170 lbs	34" - 38"
Large	170 - 200 lbs	38" - 42"
X-Large	200 - 230 lbs	42" - 46"
XX-Large	230 - 260 lbs	46" - 50"
XXX-Large	260 - 290 lbs	50" - 54"



SU-4BRB



SU-5BW



FEATURES:-

- Nylon fabric conceals the PU inner to provide untearable quality while enabling thermal insulation to retain heat efficiently.
- Shed 20% more water weight using this smartly designed Sauna Suit with drawstring hoodie and zipper.
- Elastics on cuffs of Jacket and Pants traps heat, blocking it from escaping, this advertently encourages the body to heat up more resulting in maximum weight loss.
- Machine washable thanks to its sturdy non-tear design.
- Durably double-stitched slim-fit design is unbreakable.

	MEDIUM	LARGE	X-LARGE	2X-LARGE
A Waist (inches)	32" - 33"	34" - 35"	36" - 37"	38" - 40"
A Waist (centimeters)	81 _{cm} - 83 _{cm}	86 _{cm} - 88 _{cm}	91 _{cm} - 93 _{cm}	96 _{cm} - 101 _{cm}
B Trouser Length (centimeters)	108 _{cm}	110 _{cm}	112 _{cm}	114 _{cm}
C Chest (centimeters)	66 _{cm}	68 _{cm}	70 _{cm}	72 _{cm}
D Sleeve Length (centimeters)	58 _{cm}	60 _{cm}	62 _{cm}	64 _{cm}

* There might be tolerance of 0.5" / 1cm in every measurement.

FEATURES:-

- Non-hazardous Evalon™ built for improved sturdiness and over 70% better efficiency.
- High-quality Zippex™ closure adjusted in the trouser cuff.
- Improved Quick-Ez™ Velcro in Pullover's cuff for adjustability.
- Additional cord in the neck to keep avoid slipping of hoodie.
- Advanced DS-Seam™ stitching for ultimate strength and enhanced resilience.

	MEDIUM	LARGE	X-LARGE	2X-LARGE
A Waist (inches)	32" - 33"	34" - 35"	36" - 37"	38" - 40"
A Waist (centimeters)	81 _{cm} - 83 _{cm}	86 _{cm} - 88 _{cm}	91 _{cm} - 93 _{cm}	96 _{cm} - 101 _{cm}
B Trouser Length (centimeters)	108 _{cm}	110 _{cm}	112 _{cm}	114 _{cm}
C Chest (centimeters)	66 _{cm}	68 _{cm}	70 _{cm}	72 _{cm}
D Sleeve Length (centimeters)	58 _{cm}	60 _{cm}	62 _{cm}	64 _{cm}

* There might be tolerance of 0.5" / 1cm in every measurement.



FEATURES:-

- Superior synthetic construction for a kit bag with low absorbency.
- Abrasion proof design for a tough sports holdall that will last and last.
- Tarpaulin sides and bottom to repel water keeping your gym kit dry in all weather.
- Resistant to fungi and moths for clean and durable sports gear bag.
- Highly adjustable sternum fastening and padded straps for support and comfort.

SB-2BU

FEATURES:-

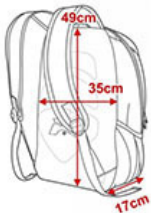
- Superior synthetic fabric with low absorbency and high resilience.
- Tarpaulin bottom and sides for water repelling capabilities to keep your kit dry.
- Resistant to fungi and moths for a sports gear bag that lasts and lasts.
- Anti-abrasion design to prevent scuffs and visible signs of wear and tear.
- Adjustable chest strap and padded shoulder straps for comfort and heavy load support.

SB-BR

FEATURES:-

- Nylon, mesh, foam and rubber included 23" high and 11" wide backpack or a duffel bag.
- Backpack straps can be hidden behind a panel U-shaped zippered main compartment with a sectioned off shoe compartment.
- Two side zippered pockets, Front hook & loop pocket and top zippered pocket.
- Handle on the sides with comfort grip.
- Two detachable shoulder straps.

SB-6BR

FEATURES:-

- KATANA Power-Pack Gym Bag is perfect for the Gym and Sports Equipment.
- Manufactured from powerful synthetic material with low absorbency.
- Dual-zip main compartment allows awesome storage capacity. Separate compartment for shoes.
- Side accessory pockets for easy storage of a full range of items.
- Adjustable padded shoulder strap for a customizable fit.

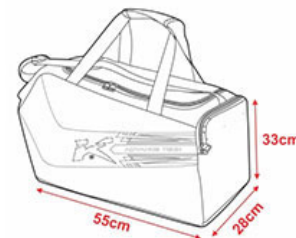
SB-8BG